



TOP LEVEL

Glasværn

Gelændersystemer





MAB TOP LEVEL GLAS SYSTEM

-opfylder bygningskrav.

1

- Top Level systemerne er en sikker holdbar løsning, til såvel det professionelle, som private segment. Hvert produkt har sine specielle fordele, således at alle behov, såvel sidemonteret som topmonteret opfyldes. Top Level glas systemerne giver flot udseende og dokumenteret sikkerhed.
- Udseendet samt ønsket styrke, spiller en vigtig rolle, i alle beslutninger. De viste løsninger afdækker dette behov, har du særlige ønsker spørg i vor projektafdeling.
- Systemerne monteres efter montageanvisning således, at det rigtige resultat opnås. Vælg mellem forskellige løsninger, et modulopbygget system, gør det nemt at vælge den løsning, der passer til dit projekt.
- Top Level systemerne er montage klare med montagepunkter, tilbehør tilvælges efter glas løsning og montage situation. Top Level systemerne er overfladebehandlet med eloxering på 25 µm. ønsker du pulverlakerede farver, angiv ral farve.
- Drænsystem for kontrolleret afvanding af fals.
- Samlesystem til at forbinde profil/profil.
- Har du spørgsmål til det rigtige valg, kontakt vor salgsafdeling.
- info@mabglas.dk
- Tlf.: +45 9752 6533



Top Level glass system..Nemt og bekvemt!

TOP LEVEL 1515

1.0 til 5.1 kN topmonteret



For projekterende.

beskrivelse til udbudsmateriale.

MAB TOP LEVEL TL1515

1.0-5.2 kN Topmonteret
(vare nr.: 022650-51 og 52)

Linjelast 1.0 til 5.1 kN

(håndliste: 021260)
(montage anker: 022461)

Secur sikkerhedsglas

MAB secur hærdet lamineret
glas 88.4 til 1212.4
(17.52 til 25.52 mm.)

Glashøjde

Standard testet
til 1100 mm.

Kontakt os for DWG tegninger
og specifikke tekniske detaljer.

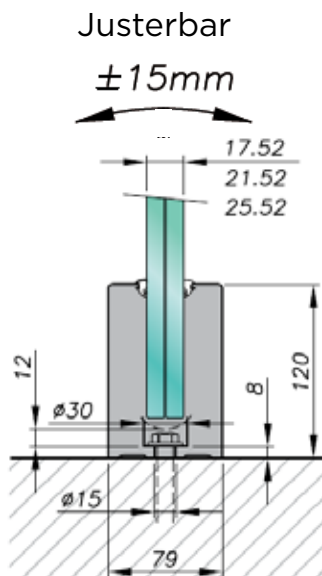

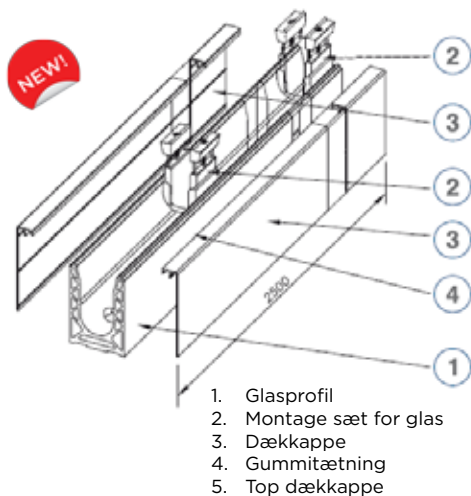

Glasprofil topmonteret 1.0/5.1 kN - KIT

TL1515	Udendørs / Outdoor		Aluminium
Vare nr.	Glas	Længde	Pakning
022650	17.52 mm.	2500 mm.	1 sæt
022651	21.52 mm.	2500 mm.	1 sæt
022652	25.52 mm.	2500 mm.	1 sæt

	Private	Offentlig	Offentlig	
Test	1,8 Kn	3 Kn	5,1 Kn	
Befæstigelses afstand	400 mm	400 mm	200 mm	
Glas tykkelse	8.8.2 PVB	4 pr./m		
	8.8.2 EVA	4 pr./m	4 pr./m	
	8.8.2 Trosifol	4 pr./m	4 pr./m	
	8.8.2 DG41	4 pr./m	4 pr./m	
	8.8.2 SGP	4 pr./m	4 pr./m	
	10.10.4 PVB	4 pr./m	4 pr./m	
	10.10.2 EVA	4 pr./m	4 pr./m	
	10.10.2 Trosifol	4 pr./m	4 pr./m	5 pr./m
	10.10.2 DG41	4 pr./m	4 pr./m	5 pr./m
	19 mono			
	10.10.2 Serac50 trempé (10.10 SGP)	4 pr./m	4 pr./m	5 pr./m
	10.10.2 Serac50 (Float)	5 pr./m		
	12.12.2 Serac60 (Float)	5 pr./m		
	12.12.4 PVB	4 pr./m	4 pr./m	5 w./m
12.12.2 EVA	4 pr./m	4 pr./m	5 w./m	
12.12.2 SGP	4 pr./m	4 pr./m	5 pr./m	

Godkendt Acceptabelt Ikke godkent

Test for topmonteret (test: cahier 3034)



Endeluk

TL1515	Udendørs / Outdoor		Aluminium
Vare nr.	Pakning		
022660			1 stk

Gummitætning

TL1515	Udendørs / Outdoor		Rubber
Vare nr.	Glas	Længde	Pakning
022662	17.52 mm.	50 m.	1 rulle
022663	21.52 mm.	50 m.	1 rulle
022664	25.52 mm.	50 mm.	1 rulle

TOP LEVEL 1515

1.0 til 3.0 kN sidemonteret



For projekterende.

beskrivelse til udbudsmateriale.

MAB TOP LEVEL TL1515

1.0 - 3.0 kN Sidemonteret
(vare nr.: 022655-56 og 57)

Linjelast 1.0 til 5.1 kN

(håndliste: 021260)
(montage anker: 022461)

Secur sikkerhedsglas

MAB secur hærdet lamineret
glas 88.4 til 1212.4
(17.52 til 25.52 mm.)

Glashøjde

Standard testet
til 1100 mm.

Kontakt os for DWG tegninger
og specifikke tekniske detaljer.

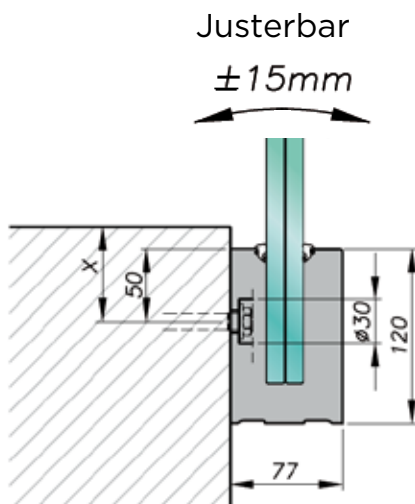

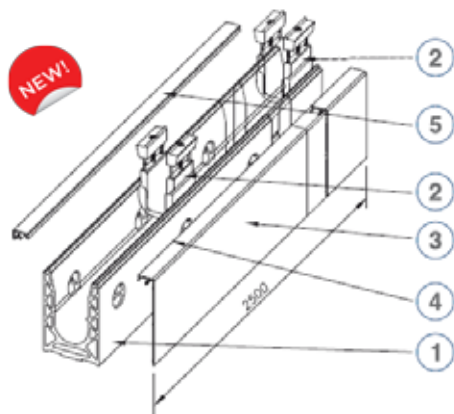

1. Glasprofil
2. Montage sæt for glas
3. Dækkappe
4. Gummitætning
5. Top dækkappe

Glasprofil sidemonteret 1.0/3.0 kN - KIT

TL1515	Udendørs / Outdoor		Aluminium
Vare nr.	Glas	Længde	Pakning
022655	17.52 mm.	2500 mm.	1 sæt
022656	21.52 mm.	2500 mm.	1 sæt
022657	25.52 mm.	2500 mm.	1 sæt

	Private	Offentlig	
Test	1,8 Kn	3 Kn	
Befæstigelses afstand	200 mm	200 mm	
Glas tykkelse	8.8.2 PVB		
	8.8.2 EVA		
	8.8.2 Trosifol	4 pr./m	4 pr./m
	8.8.2 DG41	4 pr./m	4 pr./m
	8.8.2 SGP	4 pr./m	4 pr./m
	10.10.4 PVB	4 pr./m	4 pr./m
	10.10.2 EVA	4 pr./m	4 pr./m
	10.10.2 Trosifol	4 pr./m	4 pr./m
	10.10.2 DG41	4 pr./m	4 pr./m
	19 mono		
	10.10.2 Serac 50 trempé (10.10 SGP)	4 pr./m	4 pr./m
	10.10.2 Serac 50 (Float)		
	12.12.2 Serac 60 (Float)	5 pr./m	
	12.12.4 PVB	4 pr./m	4 pr./m
12.12.2 EVA	4 pr./m	4 pr./m	
12.12.2 SGP	4 pr./m	4 pr./m	

Godkendt Acceptabelt Ikke godkendt

Test for sidemonteret (test: cahier 3034)



Endeluk

TL1515	Udendørs / Outdoor		Aluminium
Vare nr.	Pakning		
022660	1 stk		

Gummitætning

TL1515	Udendørs / Outdoor		Rubber
Vare nr.	Glas	Længde	Pakning
022662	17.52 mm.	50 m.	1 rulle
022663	21.52 mm.	50 m.	1 rulle
022664	25.52 mm.	50 mm.	1 rulle

TOP LEVEL 1530

1.0 kN topmonteret



For projekterende.
beskrivelse til udbudsmateriale.

MAB TOP LEVEL TL1530

1.0 kN top monteret
(vare nr.: 022078 eller 022079)

Linjelast 1.0 kN

(håndliste: 021260)
(montage anker: 022458)

Secur sikkerhedsglas

MAB secur hærdet lamineret
glas 12 til 1010.4
(12 til 21.52 mm.)

Glashøjde

Standard mellem
1000 og 1200 mm.

Kontakt os for DWG tegninger
ogspecifikke tekniske detaljer.

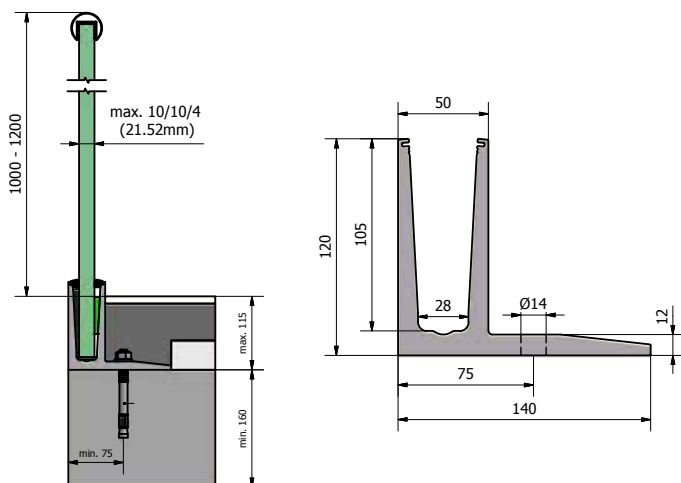

OBS! de angivne kN er forudsat at der er monteret håndliste.

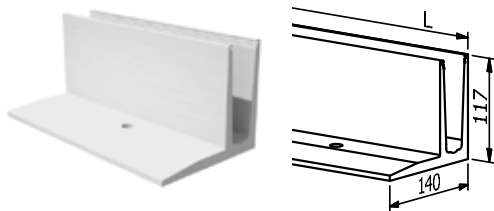

Glasprofil 1.0 kN

TL1530	Udendørs / Outdoor	Aluminium
Vare nr.	Længde	Pakning
022078	2500 mm.	1 stk.
022079	5000 mm.	1 stk. *Bestillings vare

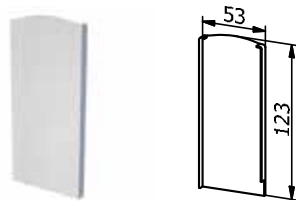

Endeluk

TL1530	Udendørs / Outdoor	Aluminium
Vare nr.	Type	Pakning
022082	Venstre	1 stk.
022083	Højre	1 stk.

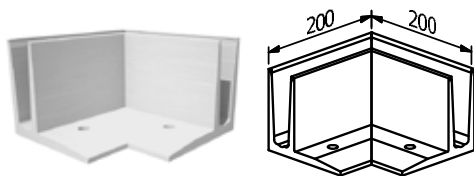

Udvendig hjørne

TL1530	Udendørs / Outdoor	Aluminium
Vare nr.	Pakning	
022081	1 stk.	

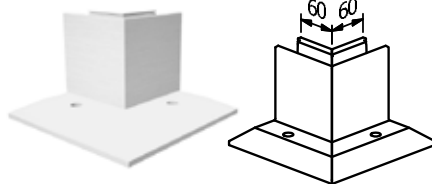

Indvendig hjørne

TL1530	Udendørs / Outdoor	Aluminium
Vare nr.	Pakning	
022080	1 stk.	



Montage anker

UNI.	Udendørs / Outdoor	Zink - galv.
Vare nr.	L	Pakning
022458	120	20 stk.



1

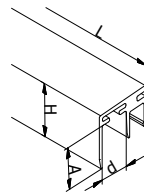
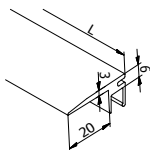

Tilslutningsprofil for gulv

UNI.	Udendørs / Outdoor	AISI 316		
Vare nr.	Type	Længde	Pakning	
022280	Gulv profil	2500 mm.	1 stk.	
022281	Gulv profil	5000 mm.	1 stk.	*Bestillings vare

Tilslutningsprofil til 1.0 kN profil.

UNI	Udendørs / Outdoor	Aluminium		
Vare nr.	d	Længde	Pakning	
022246	3 mm.	2500 mm.	1 stk.	
022247	3 mm.	5000 mm.	1 stk.	*Bestillings vare
022248	10 mm.	2500 mm.	1 stk.	
022249	10 mm.	5000 mm.	1 stk.	*Bestillings vare
022250	20 mm.	2500 mm.	1 stk.	
022251	20 mm.	5000 mm.	1 stk.	*Bestillings vare
022252	120 mm.	2500 mm.	1 stk.	
022253	120 mm.	5000 mm.	1 stk.	*Bestillings vare

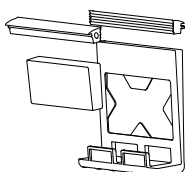

Top-Fix-Kit for 1.0 kN - 2500 mm.

UNI.	Udendørs / Outdoor		
Vare nr.	Farve	Glas	Længde
022316		12 mm.	2500 mm.
022317		66.2	2500 mm.
022320		88.4	2500 mm.
022322		1010.4	2500 mm.

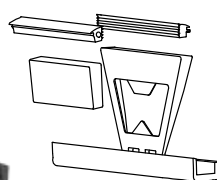

Top-Flex-Kit for 1.0 kN - 2500 mm.

UNI.	Udendørs / Outdoor		
Vare nr.	Farve	Glas	Længde
022346		12 mm.	2500 mm.
022347		66.2	2500 mm.
022350		88.4	2500 mm.
022352		1010.4	2500 mm.

Top-Fix-Kit for 1.0 kN - 5000 mm.

UNI.	Udendørs / Outdoor		
Vare nr.	Farve	Glas	Længde
022323		12 mm.	5000 mm.
022324		66.2	5000 mm.
022327		88.4	5000 mm.
022329		1010.4	5000 mm.

Top-Flex-Kit for 1.0 kN - 5000 mm.

UNI.	Udendørs / Outdoor		
Vare nr.	Farve	Glas	Længde
022356		12 mm.	5000 mm.
022357		66.2	5000 mm.
022359		88.4	5000 mm.
022361		1010.4	5000 mm.



TOP LEVEL 1530

3.0 kN topmonteret



For projekterende.
beskrivelse til udbudsmateriale.

MAB TOP LEVEL TL1530

3.0 kN top monteret

(vare nr.: 022084)

Linjelast 3.0 kN

(håndliste: 021260)

(montage anker: 022459)

Secur sikkerhedsglas

MAB secur hærdet lamineret
glas 1212,4 til 1515,4

(25,52 til 31,52 mm.)

Glashøjde

Standars mellem

1000 og 1200 mm.

Kontakt os for DWG tegninger
og specifikke tekniske detaljer.

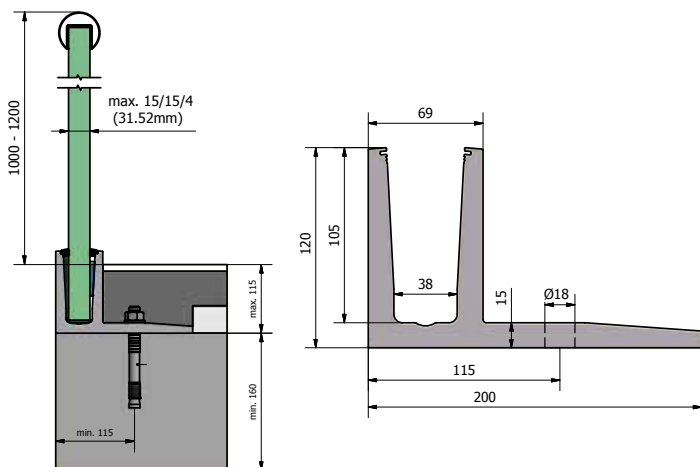

OBS! de angivne kN er forudsat at der er monteret håndliste.

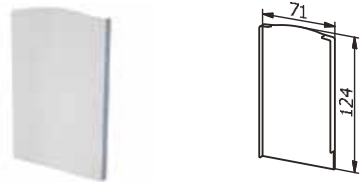
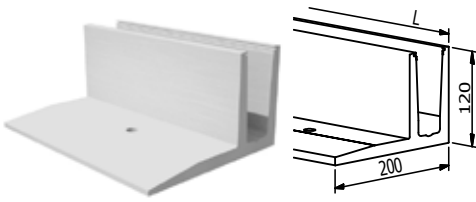

Glasprofil 3.0 kN

TL1530	Udendørs / Outdoor	Aluminium
Vare nr.	Længde	Pakning
022084	2500 mm.	1 stk.

Endeluk

TL1530	Udendørs / Outdoor	Aluminium
Vare nr.	Type	Pakning
022087	Venstre	1 stk.
022088	Højre	1 stk.

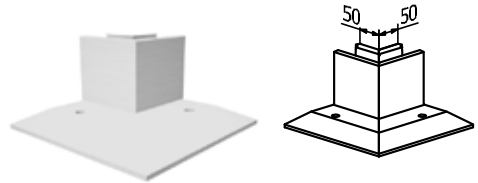
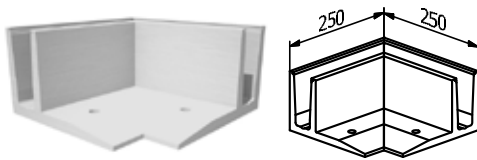

Udvendig hjørne

TL1530	Udendørs / Outdoor	Aluminium
Vare nr.	Pakning	
022086	1 stk.	

Indvendig hjørne

TL1530	Udendørs / Outdoor	Aluminium
Vare nr.	Pakning	
022085	1 stk.	



Montage anker

UNI.	Udendørs / Outdoor	Zink - galv.
Vare nr.	L	Pakning
022459	148	10 stk.

MAB
GLASS

1

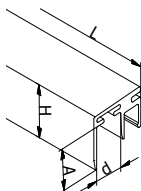

Tilslutningsprofil til 3.0 kN profil

UNI	Udendørs / Outdoor		Aluminium
Vare nr.	d	Længde	Pakning
022271	3 mm.	2500 mm.	1 stk.
022272	3 mm.	5000 mm.	1 stk. *Bestillings vare
022273	10 mm.	2500 mm.	1 stk.
022274	10 mm.	5000 mm.	1 stk. *Bestillings vare
022275	20 mm.	2500 mm.	1 stk.
022276	20 mm.	5000 mm.	1 stk. *Bestillings vare

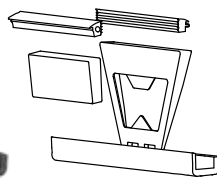
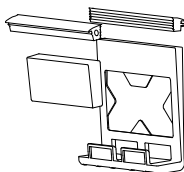

Top-Fix-Kit for 3.0 kN - 2500 mm.

UNI.	Udendørs / Outdoor		Længde
Vare nr.	Farve	Glas	Længde
022380	Red	1010.4	2500 mm.
022381	Grey	1212.4	2500 mm.
022382	Black	1515.4	2500 mm.

Top-Flex-Kit for 3.0 kN - 2500 mm.

UNI.	Udendørs / Outdoor		Længde
Vare nr.	Farve	Glas	Længde
022353	Red	1010.4	2500 mm.
022354	Grey	1212.4	2500 mm.
022355	Black	1515.4	2500 mm.

Top-Fix-Kit for 3.0 kN - 5000 mm.

UNI.	Udendørs / Outdoor		Længde
Vare nr.	Farve	Glas	Længde
022330	Red	1010.4	5000 mm
022331	Grey	1212.4	5000 mm.
022332	Black	1515.4	5000 mm.

Top-Flex-Kit for 3.0 kN - 5000 mm.

UNI.	Udendørs / Outdoor		Længde
Vare nr.	Farve	Glas	Længde
022362	Red	1010.4	5000 mm
022363	Grey	1212.4	5000 mm.
022364	Black	1515.4	5000 mm.



TOP LEVEL 1530

1.0 kN sidemonteret



For projekterende.
beskrivelse til udbudsmateriale.

MAB TOP LEVEL TL1530

1.0 kN Side monteret
(vare nr.: 022108 eller 022109)

Linjelast 1.0 kN

(håndliste: 021260)
(montage anker: 022462)

Secur sikkerhedsglas

MAB secur hærdet lamineret
glas 12 til 1010.4
(12 til 21.52 mm.)

Glashøjde

Standard mellem
1000 og 1200 mm.

Kontakt os for DWG tegninger
og specifikke tekniske detaljer.

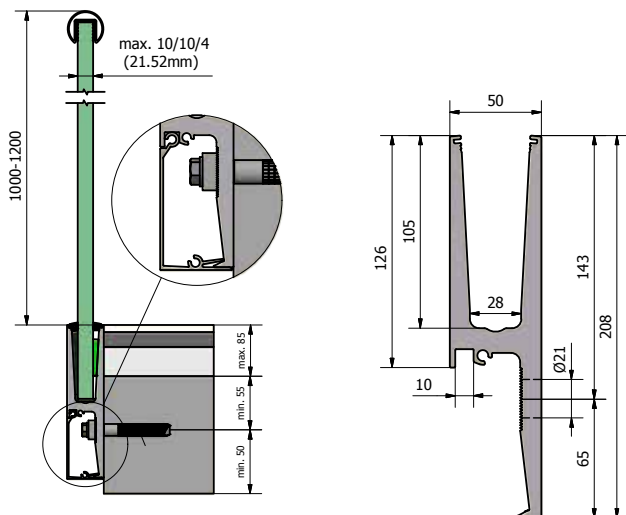

OBS! de angivne kN er forudsat at der er monteret håndliste.

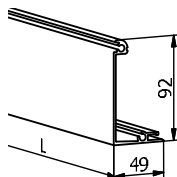
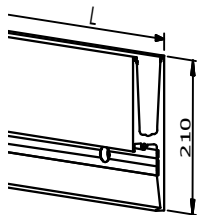

Glasprofil 1.0 kN

TL1530	Udendørs / Outdoor	Aluminium
Vare nr.	Længde	Pakning
022108	2500 mm.	1 stk.
022109	5000 mm.	1 stk. *Bestillings vare

Dækkape

TL1530	Udendørs / Outdoor	Aluminium
Vare nr.	Længde	
022112	2500 mm.	
022113	5000 mm.	*Bestillings vare

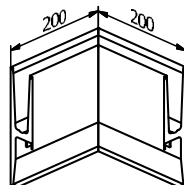
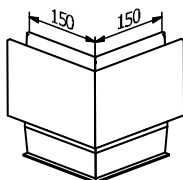

Udvendig hjørne

TL1530	Udendørs / Outdoor	Aluminium
Vare nr.	Pakning	
022111	1 stk.	

Indvendig hjørne

TL1530	Udendørs / Outdoor	Aluminium
Vare nr.	Pakning	
022110	1 stk.	

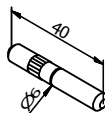

Endeluk

TL1530	Udendørs / Outdoor	Aluminium
Vare nr.	Model	Pakning
022120	Venstre	1 stk.
022121	Højre	1 stk.

Samle stift "Stift-it"

UNI.	Udendørs / Outdoor	AISI 316
Vare nr.	Type	Pakning
022296	Samle stift	8 stk.

Top level 1530 1.0 kN

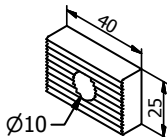

Montageblok

UNI.	Udendørs / Outdoor	Aluminium
Vare nr.	Pakning	
022435	8 stk.	

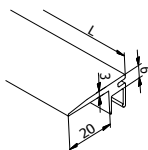

Tilslutningsprofil for gulv

UNI.	Udendørs / Outdoor	AISI 316	
Vare nr.	Type	Længde	Pakning
022279	Gulv profil	2500 mm.	1 stk.
022280	Gulv profil	5000 mm.	1 stk *Bestillings vare

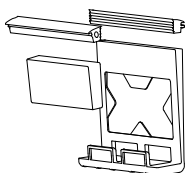

Top-Fix-Kit for 1.0 kN - 2500 mm.

UNI.	Udendørs / Outdoor		
Vare nr.	Farve	Glas	Længde
022316	Black	12 mm.	2500 mm.
022317	Red	66.2	2500 mm.
022320	Green	88.4	2500 mm.
022322	Light Green	1010.4	2500 mm.

Top-Fix-Kit for 1.0 kN - 5000 mm.

UNI.	Udendørs / Outdoor		
Vare nr.	Farve	Glas	Længde
022323	Black	12 mm.	5000 mm.
022324	Red	66.2	5000 mm.
022327	Green	88.4	5000 mm.
022329	Light Green	1010.4	5000 mm.

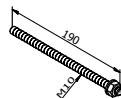

Montage anker

UNI.	Udendørs / Outdoor	Zink - galv.
Vare nr.	Antal pr. 2500 mm.	
022462	7 stk.	

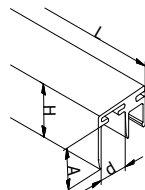

Tilslutningsprofil til 1.0 kN profil.

TL 1500	Udendørs / Outdoor	Aluminium	
Vare nr.	d	Længde	Pakning
022246	3 mm.	2500 mm.	1 stk.
022247	3 mm.	5000 mm.	1 stk. *Bestillings vare
022248	10 mm.	2500 mm.	1 stk.
022249	10 mm.	5000 mm.	1 stk. *Bestillings vare
022250	20 mm.	2500 mm.	1 stk.
022251	20 mm.	5000 mm.	1 stk. *Bestillings vare
022252	120 mm.	2500 mm.	1 stk.
022253	120 mm.	5000 mm.	1 stk. *Bestillings vare

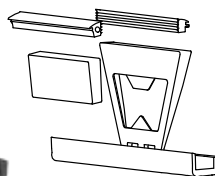

Top-Flex-Kit for 1.0 kN - 2500 mm.

UNI.	Udendørs / Outdoor		
Vare nr.	Farve	Glas	Længde
022346	Black	12 mm.	2500 mm.
022347	Red	66.2	2500 mm.
022350	Green	88.4	2500 mm.
022352	Light Green	1010.4	2500 mm.

Top-Flex-Kit for 1.0 kN - 5000 mm.

UNI.	Udendørs / Outdoor		
Vare nr.	Farve	Glas	Længde
022356	Black	12 mm.	5000 mm.
022357	Red	66.2	5000 mm.
022359	Green	88.4	5000 mm.
022361	Light Green	1010.4	5000 mm.



TOP LEVEL 1530

3.0 kN sidemonteret



For projekterende.
beskrivelse til udbudsmateriale.

MAB TOP LEVEL TL1530

3.0 kN Side monteret

(vare nr.: 022114)

Linjelast 3.0 kN

(håndliste: 021260)

(montage anker: 022462)

(montage kit: 021435)

Secur sikkerhedsglas

MAB secur hærdet lamineret

glas 1212.4 til 1515.4

(21.52 til 31.52 mm.)

Glashøjde

Standard mellem

1000 og 1200 mm.

Kontakt os for DWG tegninger
og specifikke tekniske detaljer.

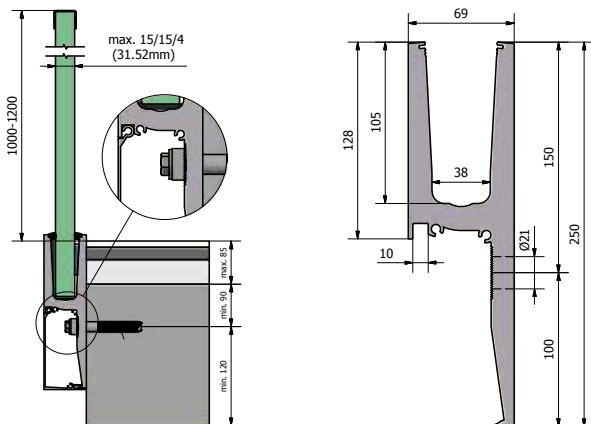

OBS! de angivne kN er forudsat at der er monteret håndliste.

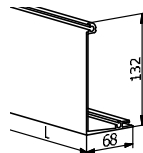
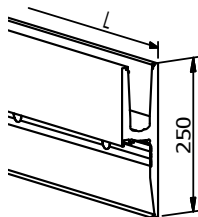

Glasprofil 3.0 kN

TL1530	Udendørs / Outdoor	Aluminium
Vare nr.	Længde	Pakning
022114	2500 mm.	1 stk.

Dækkape

TL1530	Udendørs / Outdoor	Aluminium
Vare nr.	Længde	
022117	2500 mm.	
022118	5000 mm.	*Bestillings vare

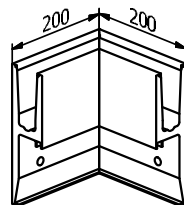
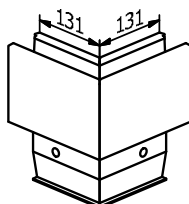

Udvendig hjørne

TL1530	Udendørs / Outdoor	Aluminium
Vare nr.	Pakning	
022116	1 stk.	

Indvendig hjørne

TL1530	Udendørs / Outdoor	Aluminium
Vare nr.	Pakning	
022115	1 stk.	

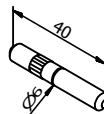
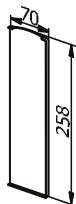

Endeluk

TL1530	Udendørs / Outdoor	Aluminium
Vare nr.	Model	Pakning
022122	Venstre	1 stk.
02212	Højre	1 stk.

Samle stift "Stift-it"

UNI.	Udendørs / Outdoor	AISI 316
Vare nr.	Type	Pakning
022296	Samle stift	8 stk.

Top level 1530 3.0 kN

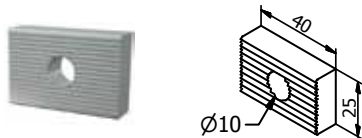

Montageblok

UNI.	Udendørs / Outdoor	Aluminium
Vare nr.	Pakning	
022435	8 stk.	



Montage anker

UNI.	Udendørs / Outdoor	Zink - galv.
Vare nr.	Antal pr. 2500 mm.	
022462	7 stk.	

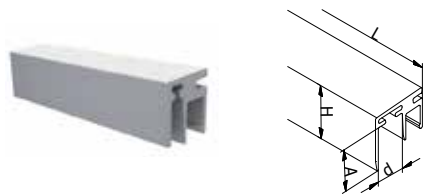

Tilslutningsprofil til 3.0 kN profil

TL1500	Udendørs / Outdoor	Aluminium
Vare nr.	d	Længde
022271	3 mm.	2500 mm.
022272	3 mm.	5000 mm.
022273	10 mm.	2500 mm.
022274	10 mm.	5000 mm.
022275	20 mm.	2500 mm.
022276	20 mm.	5000 mm.

MAB
GLASS

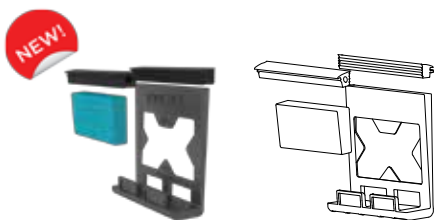

Top-Fix-Kit for 3.0 kN - 2500 mm.

UNI.	Udendørs / Outdoor			
Vare nr.	Farve	Glas	Længde	
022380	Red	1010.4	2500 mm.	
022381	Grey	1212.4	2500 mm.	
022382	Black	1515.4	2500 mm.	

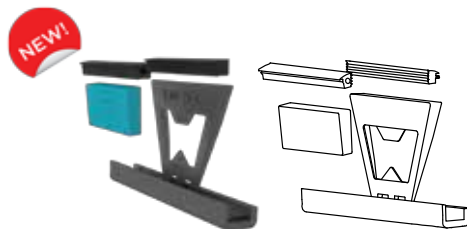

Top-Flex-Kit for 3.0 kN - 2500 mm.

UNI.	Udendørs / Outdoor			
Vare nr.	Farve	Glas	Længde	
022353	Red	1010.4	2500 mm.	
022354	Grey	1212.4	2500 mm.	
022355	Black	1515.4	2500 mm.	

Top-Fix-Kit for 3.0 kN - 5000 mm.

UNI.	Udendørs / Outdoor			
Vare nr.	Farve	Glas	Længde	
022330	Red	1010.4	5000 mm	
022331	Grey	1212.4	5000 mm.	
022332	Black	1515.4	5000 mm.	

Top-Flex-Kit for 3.0 kN - 5000 mm.

UNI.	Udendørs / Outdoor			
Vare nr.	Farve	Glas	Længde	
022362	Red	1010.4	5000 mm	
022363	Grey	1212.4	5000 mm.	
022364	Black	1515.4	5000 mm.	



TOP LEVEL 1550

1.0 kN topmonteret



For projekterende.

beskrivelse til udbudsmateriale.

MAB TOP LEVEL TL1550

1.0 kN Topmonteret

(vare nr.: 022138 eller 022139)

Linjelast 1.0 kN

(håndliste: 021260)

(montage anker: 022458)

(montage blok: 021146)

(fod: 021144 eller 021145)

Secur sikkerhedsglas

MAB secur hærdet lamineret

glas 12 til 1010.4

(12 til 21.52 mm.)

Glashøjde

Standard mellem

1000 og 1200 mm.

Kontakt os for DWG tegninger
og specifikke tekniske detaljer.

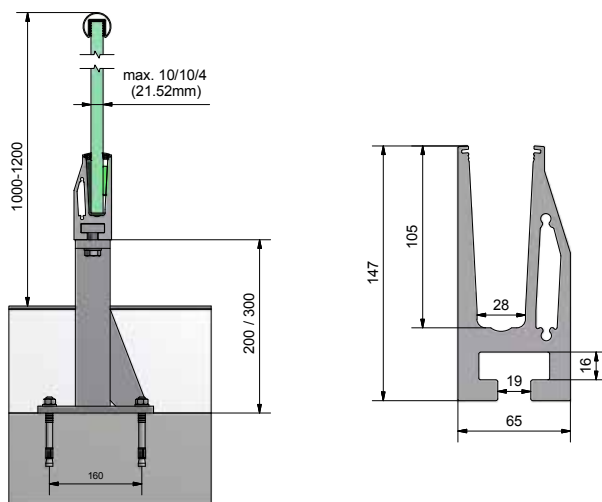

OBS! de angivne kN er forudsat at der er monteret håndliste.

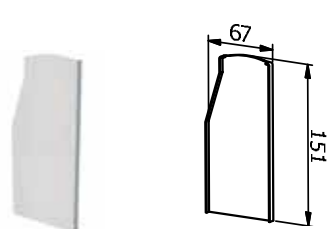
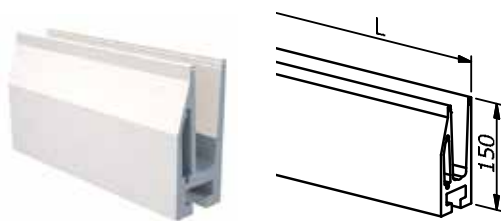

Glasprofil 1.0 kN

TL1550	Udendørs / Outdoor	Aluminium
Vare nr.	Længde	Pakning
022138	2500 mm.	1 stk.
022139	5000 mm.	1 stk. *Bestillings vare

Endeluk

TL1550	Udendørs / Outdoor	Aluminium
Vare nr.	Type	Pakning
022142	Venstre	1 stk.
022143	Højre	1 stk.

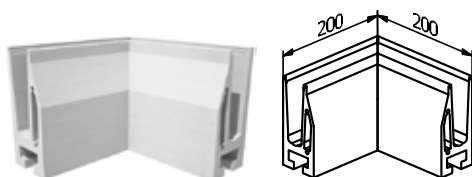
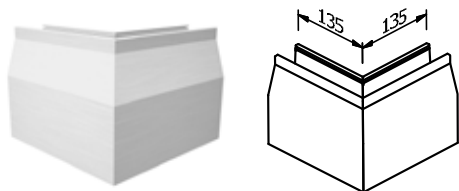

Udvendig hjørne

TL1550	Udendørs / Outdoor	Aluminium
Vare nr.	Pakning	
022141	1 stk.	

Indvendig hjørne

TL1550	Udendørs / Outdoor	Aluminium
Vare nr.	Pakning	
022140	1 stk.	

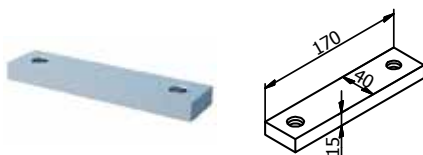
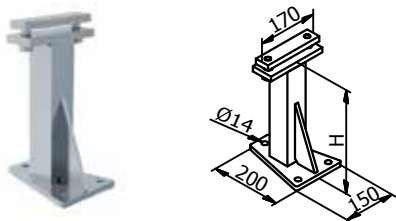

Fod

TL1550	Udendørs / Outdoor	Zink - galv.
Vare nr.	H	Pakning
022145	200	1 stk.
022144	300	1 stk.

Montage blok

TL1550	Udendørs / Outdoor	Aluminium
Vare nr.	Pakning	
022146	4 stk.	

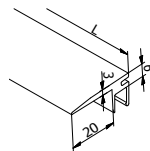
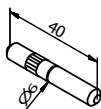

Samle stift "Stift-it"

UNI.	Udendørs / Outdoor	AISI 316
Vare nr.	Type	Pakning
022296	Samle stift	8 stk.

Tilslutningsprofil for gulv

UNI.	Udendørs / Outdoor	Aluminium	
Vare nr.	Type	Længde	Pakning
022279	Gulv profil	2500 mm.	1 stk.
022280	Gulv profil	5000 mm.	1 stk. *Bestillings vare

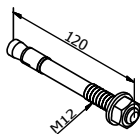

Montage anker

UNI.	Udendørs / Outdoor	Zink - galv.
Vare nr.	L	Pakning
022458	120	25 stk.

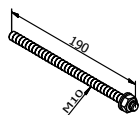

Montage anker

UNI.	Udendørs / Outdoor	Zink - galv.
Vare nr.	Antal pr. 2500 mm.	
022462	7 stk.	

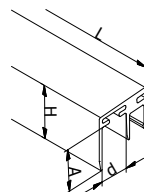

Tilslutningsprofil til 1.0 kN profil.

TL 1500	Udendørs / Outdoor	Aluminium	
Vare nr.	d	Længde	Pakning
022246	3 mm.	2500 mm.	1 stk.
022247	3 mm.	5000 mm.	1 stk. *Bestillings vare
022248	10 mm.	2500 mm.	1 stk.
022249	10 mm.	5000 mm.	1 stk. *Bestillings vare
022250	20 mm.	2500 mm.	1 stk.
022251	20 mm.	5000 mm.	1 stk. *Bestillings vare
022252	120 mm.	2500 mm.	1 stk.
022253	120 mm.	5000 mm.	1 stk. *Bestillings vare

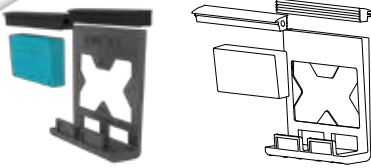

Top-Fix-Kit for 1.0 kN - 2500 mm.

UNI.	Udendørs / Outdoor		
Vare nr.	Farve	Glas	Længde
022316	Black	12 mm.	2500 mm.
022317	Red	66.2	2500 mm.
022320	Green	88.4	2500 mm.
022322	Green	1010.4	2500 mm.

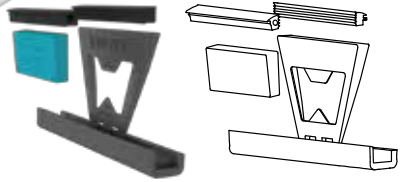

Top-Flex-Kit for for 1.0 kN - 2500 mm.

UNI.	Udendørs / Outdoor		
Vare nr.	Farve	Glas	Længde
022346	Black	12 mm.	2500 mm.
022347	Red	66.2	2500 mm.
022350	Green	88.4	2500 mm.
022352	Green	1010.4	2500 mm.

Top-Fix-Kit for 1.0 kN - 5000 mm.

UNI.	Udendørs / Outdoor		
Vare nr.	Farve	Glas	Længde
022323	Black	12 mm.	5000 mm.
022324	Red	66.2	5000 mm.
022327	Green	88.4	5000 mm.
022329	Green	1010.4	5000 mm.

Top-Flex-Kit for for 1.0 kN - 5000 mm.

UNI.	Udendørs / Outdoor		
Vare nr.	Farve	Glas	Længde
022356	Black	12 mm.	5000 mm.
022357	Red	66.2	5000 mm.
022359	Green	88.4	5000 mm.
022361	Green	1010.4	5000 mm.



TOP LEVEL 1580

1.0 kN topmonteret



For projekterende.
beskrivelse til udbudsmateriale.

MAB TOP LEVEL TL1580

1.0 kN topmonteret

(vare nr.: 022600)

(håndliste: 021260)

MAB TOP LEVEL TL1580

1.0 kN topmonteret

(vare nr.: 022600)

(håndliste: 021260)

Secur sikkerhedsglas

MAB secur hærdet lamineret

glas 88.4 eller 1010.4

(17.52 eller 21,52 mm.)

Glashøjde

Standard mellem

1000 og 1200 mm.

Kontakt os for DWG tegninger
og specifikke tekniske detaljer.

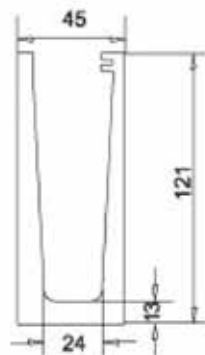

OBS! de angivne kN er forudsat at der er monteret håndliste.

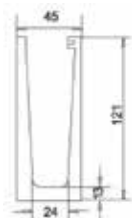

Glasprofil 1.0 kN topmonteret

TL1580		
Vare nr.	Længde	Pakning.
022600	2500 mm.	1 stk.

Endeluk TL 1580 side og topmonteret

TL1580		
Vare nr.	Model	Pakning.
022603	Topmonteret	1 stk.



Hjørne TL 1580

TL1580			
Vare nr.	Længde	Type	Pakning.
022602	200 mm.	Invendig	1 stk.
022605	200 mm.	Udvendig	1 stk.

Gummisæt TL 1580

TL1580		
Vare nr.	Glas tykkelse	Pakning.
022601	17,52 (88.4)	1 sæt.
022604	21,52 (1010.4)	1 sæt.



Montage skrue

TL1580		
Vare nr.	Type	Pakning.
033500	10x120 mm.	1 stk.
033501	10x80 mm	1 stk.
033503	Undersænket skive	1 stk.



TOP LEVEL 1580

1.0 kN sidemonteret



For projekterende.

beskrivelse til udbudsmateriale.

MAB TOP LEVEL TL1580

1.0 kN sidemonteret

(vare nr.: 022610)

(håndliste: 021260)

MAB TOP LEVEL TL1580

1.0 kN topmonteret

(vare nr.: 022610)

(håndliste: 021260)

Secur sikkerhedsglas

MAB secur hærdet lamineret

glas 88.4 eller 1010.4

(17.52 eller 21,52 mm.)

Glashøjde

Standard mellem

1000 og 1200 mm.

Kontakt os for DWG tegninger
og specifikke tekniske detaljer.

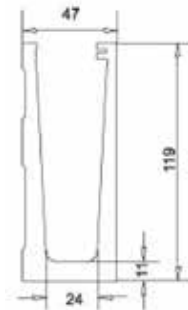

OBS! de angivne kN er forudsat at der er monteret håndliste.

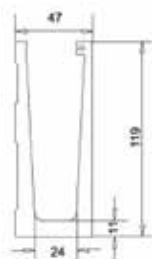

Glasprofil 1.0 kN sidemonteret

TL1580

Vare nr.	Længde	Pakning.
022610	2500 mm.	1 stk.

Endeluk TL 1580 sidemonteret

TL1580

Vare nr.	Model	Pakning.
022613	Sidemonteret	1 stk.



Hjørner sidemonteret TL 1580

TL1580

Vare nr.	Længde	Type	Pakning.
022611	200 mm.	Udvendig	1 stk.
022612	200 mm.	Indvendig	1 stk.

Gummisæt TL 1580

TL1580

Vare nr.	Glas tykkelse	Pakning.
022601	17,52 (88,4)	1 sæt.
022604	21,52 (1010,4)	1 sæt.



Prop for montage huller sidemonteret

TL1580

Vare nr.	Pakning.
022614	1 sæt.

Montage skrue

TL1580

Vare nr.	Type	Pakning.
033500	10x120 mm.	1 stk.
033501	10x80 mm	1 stk.
033503	Undersænket skive	1 stk.

TOP LEVEL 1560

1.0 kN topmonteret



For projekterende.

Beskrivelse til udbudsmateriale.

MAB TOP LEVEL TL1560

1.0 kN Topmonteret

(vare nr.: 022166 eller 022167)

Linjelast 1.0 kN

(håndliste: 021260)

(montage anker: 022461)

Secur sikkerhedsglas

MAB secur hærdet lamineret

glas 12 til 1010.4

(12 til 21.52 mm.)

Glashøjde

Standard mellem

1000 og 1200 mm.

Kontakt os for DWG tegninger
og specifikke tekniske detaljer.

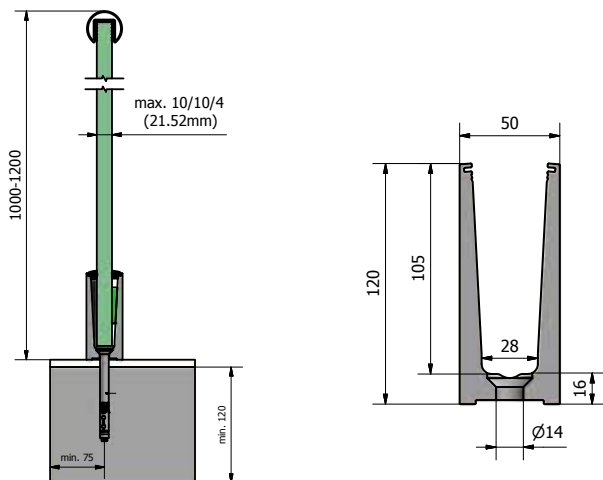

OBS! de angivne kN er forudsat at der er monteret håndliste.

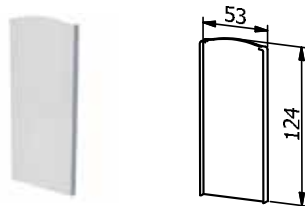
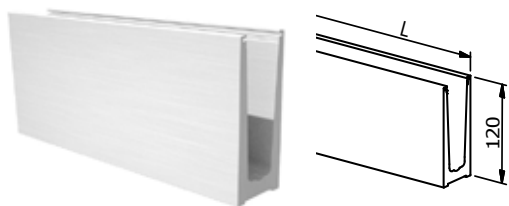

Glasprofil 1.0 kN

TL1560	Udendørs / Outdoor	Aluminium
Vare nr.	Længde	Pakning
022166	2500 mm.	1 stk.
022167	5000 mm.	1 stk. *Bestillings vare

Endeluk

TL1560	Udendørs / Outdoor	Aluminium
Vare nr.	Type	Pakning
022169	Venstre/Højre	1

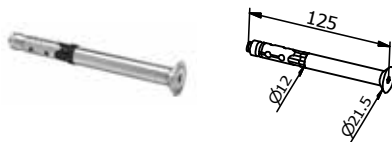

Hjørne

TL1560	Udendørs / Outdoor	Aluminium
Vare nr.	Pakning	
022168	1 stk.	

Montage anker

UNI.	Udendørs / Outdoor	Zink - galv.
Vare nr.	L	Pakning
022461	120	25 stk.



Top level 1560 1.0 kN

1

NEW!

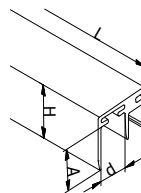
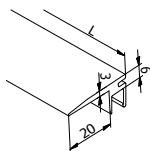

Tilslutningsprofil for gulv

UNI.	Udendørs / Outdoor	Aluminium		
Vare nr.	Type	Længde	Pakning	
022279	Gulv profil	2500 mm.	1 stk.	
022280	Gulv profil	5000 mm.	1 stk.	*Bestillings vare

Tilslutningsprofil til 1.0 kN profil.

TL 1500	Udendørs / Outdoor	Aluminium		
Vare nr.	d	Længde	Pakning	
022246	3 mm.	2500 mm.	1 stk.	
022247	3 mm.	5000 mm.	1 stk.	*Bestillings vare
022248	10 mm.	2500 mm.	1 stk.	
022249	10 mm.	5000 mm.	1 stk.	*Bestillings vare
022250	20 mm.	2500 mm.	1 stk.	
022251	20 mm.	5000 mm.	1 stk.	*Bestillings vare
022252	120 mm.	2500 mm.	1 stk.	
022253	120 mm.	5000 mm.	1 stk.	*Bestillings vare

NEW!

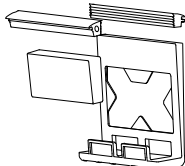

NEW!

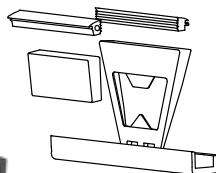

Top-Fix-Kit for 1.0 kN - 2500 mm.

UNI.	Udendørs / Outdoor			
Vare nr.	Farve	Glas	Længde	
022316	Black	12 mm.	2500 mm.	
022317	Red	66.2	2500 mm.	
022320	Green	88.4	2500 mm.	
022322	Green	1010.4	2500 mm.	

Top-Flex-Kit for 1.0 kN - 2500 mm.

UNI.	Udendørs / Outdoor			
Vare nr.	Farve	Glas	Længde	
022346	Black	12 mm.	2500 mm.	
022347	Red	66.2	2500 mm.	
022350	Green	88.4	2500 mm.	
022352	Green	1010.4	2500 mm.	

Top-Fix-Kit for 1.0 kN - 5000 mm.

UNI.	Udendørs / Outdoor			
Vare nr.	Farve	Glas	Længde	
022323	Black	12 mm.	5000 mm.	
022324	Red	66.2	5000 mm.	
022327	Green	88.4	5000 mm.	
022329	Green	1010.4	5000 mm.	

Top-Flex-Kit for 1.0 kN - 5000 mm.

UNI.	Udendørs / Outdoor			
Vare nr.	Farve	Glas	Længde	
022356	Black	12 mm.	5000 mm.	
022357	Red	66.2	5000 mm.	
022359	Green	88.4	5000 mm.	
022361	Green	1010.4	5000 mm.	



TOP LEVEL 1560

3.0 kN topmonteret



For projekterende.

Beskrivelse til udbudsmateriale.

MAB TOP LEVEL TL1560

3.0 kN Topmonteret

(vare nr.: 022170)

Linjelast 3.0 kN

(håndliste: 021260)

(montage anker: 022460)

Secur sikkerhedsglas

MAB secur hærdet lamineret

glas 12 til 1010.4

(12 til 21.52 mm.)

Glashøjde

Standard mellem

1000 og 1200 mm.

Kontakt os for DWG tegninger
og specifikke tekniske detaljer.

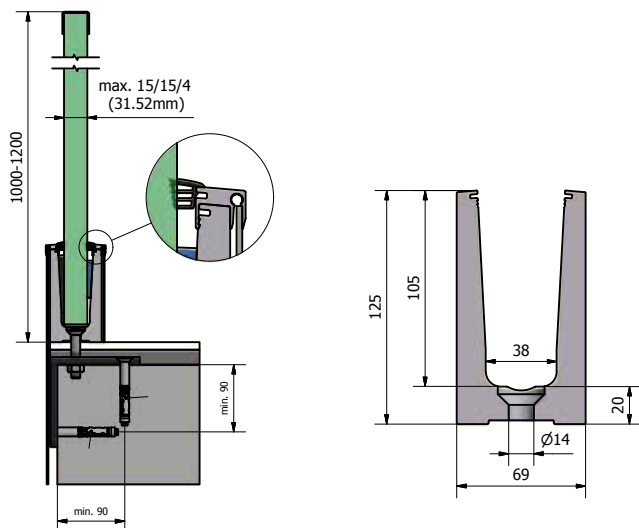

OBS! de angivne kN er forudsat at der er monteret håndliste.



Glasprofil 3.0 kN

TL1560	Udendørs / Outdoor	Aluminium
Vare nr.	Længde	Pakning
022170	2500 mm.	1 stk.

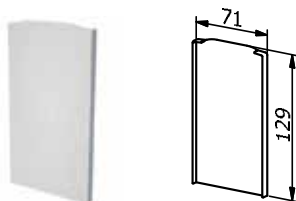

Endeluk

TL1560	Udendørs / Outdoor	Aluminium
Vare nr.	Type	Pakning
022172	Venstre/Højre	1

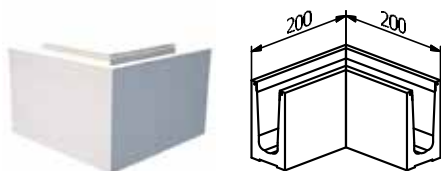

Hjørne

TL1560	Udendørs / Outdoor	Aluminium
Vare nr.	Længde	Pakning
022171		1 stk.

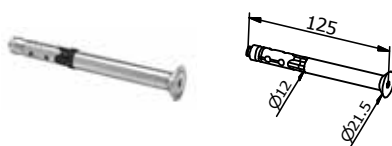

Montage anker

UNI.	Udendørs / Outdoor	Zink - galv.
Vare nr.	L	Pakning
022461	120	25 stk.



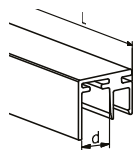

Tilslutningsprofil til 3.0 kN profil

TL1500	Udendørs / Outdoor		Aluminium
Vare nr.	d	Længde	
022271	3 mm.	2500 mm.	
022272	3 mm.	5000 mm.	*Bestillings vare
022273	10 mm.	2500 mm.	
022274	10 mm.	5000 mm.	*Bestillings vare
022275	20 mm.	2500 mm.	
022276	20 mm.	5000 mm.	*Bestillings vare

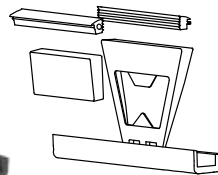
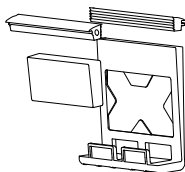

Top-Fix-Kit for 1.0 kN - 2500 mm.

UNI.	Udendørs / Outdoor		
Vare nr.	Farve	Glas	Længde
022316		12 mm.	2500 mm.
022317	Red	66.2	2500 mm.
022320	Green	88.4	2500 mm.
022322	Green	1010.4	2500 mm.

Top-Flex-Kit for 1.0 kN - 2500 mm.

UNI.	Udendørs / Outdoor		
Vare nr.	Farve	Glas	Længde
022346		12 mm.	2500 mm.
022347	Red	66.2	2500 mm.
022350	Green	88.4	2500 mm.
022352	Green	1010.4	2500 mm.

Top-Fix-Kit for 1.0 kN - 5000 mm.

UNI.	Udendørs / Outdoor		
Vare nr.	Farve	Glas	Længde
022323		12 mm.	5000 mm.
022324	Red	66.2	5000 mm.
022327	Green	88.4	5000 mm.
022329	Green	1010.4	5000 mm.

Top-Flex-Kit for 1.0 kN - 5000 mm.

UNI.	Udendørs / Outdoor		
Vare nr.	Farve	Glas	Længde
022356		12 mm.	5000 mm.
022357	Red	66.2	5000 mm.
022359	Green	88.4	5000 mm.
022361	Green	1010.4	5000 mm.



TOP LEVEL 1560

1.0 kN sidemonteret



For projekterende.

Beskrivelse til udbudsmateriale.

MAB TOP LEVEL TL1560

1.0 kN Sidemonteret

(vare nr.: 022192 eller 022193)

Linjelast 1.0 kN

(Ø48,3 håndliste: 021260)

(montage anker: 022461)

Secur sikkerhedsglas

MAB secur hærdet lamineret
glas 12 til 1010.4

(12 til 21.52 mm.)

Glashøjde

Standard mellem

1000 og 1200 mm.

Kontakt os for DWG tegninger
og specifikke tekniske detaljer.

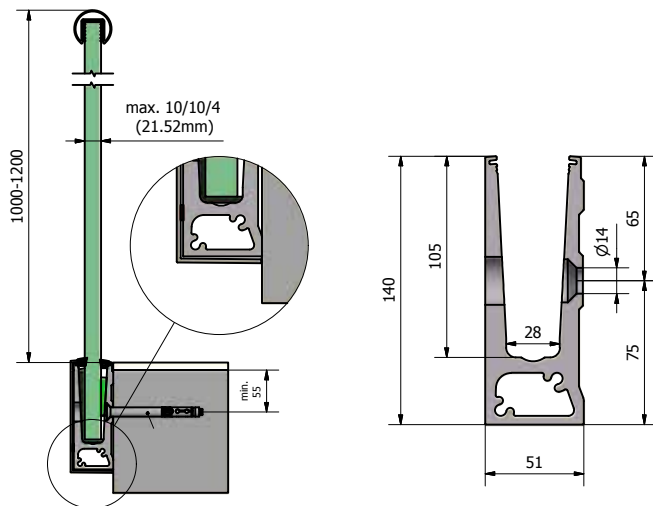

OBS! de angivne kN er forudsat at der er monteret håndliste.

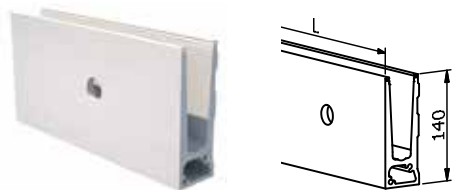

Glasprofil 1.0 kN

TL1560	Udendørs / Outdoor	Aluminium
Vare nr.	Længde	Pakning
022192	2500 mm.	1 stk.
022193	5000 mm.	1 stk. *Bestillings vare

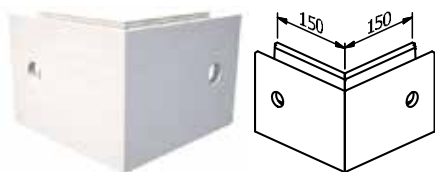

Udvendig hjørne

TL1560	Udendørs / Outdoor	Aluminium
Vare nr.	Pakning	
022195	1 stk.	

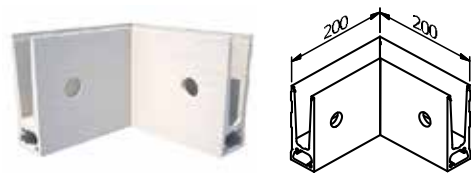

Indvendig hjørne

TL1560	Udendørs / Outdoor	Aluminium
Vare nr.	Pakning	
022194	1 stk.	



Prop for montage huller

UNI.	Udendørs / Outdoor	Kunststof
Vare nr.	Farve	Pakning
022202	Grå	10 stk.

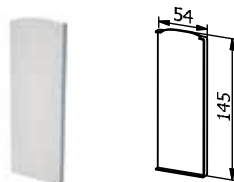

Endeluk (for brug uden dækkappe)

TL1560	Udendørs / Outdoor	Aluminium
Vare nr.	Type	Pakning
022198	Venstre	1 stk.
022199	Højre	1 stk.

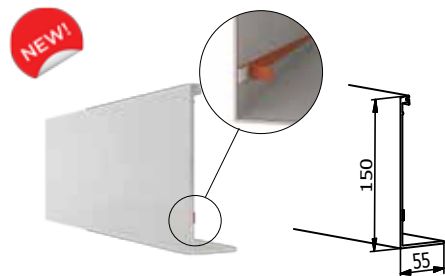

Dækkappe (OBS! brug korrekt endeluk)



TL1560	Udendørs / Outdoor	Aluminium
Vare nr.	Længde	
022196	2500 mm.	
022197	5000 mm. *Bestillings vare	

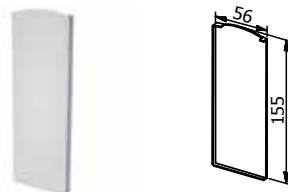

Endeluk (for brug med dækkappe)



TL1560	Udendørs / Outdoor	Aluminium
Vare nr.	Pakning	
022200	1 stk.	
022201	1 stk.	

Top level 1560 1.0 kN



Prop for montage huller

UNI.	Udendørs / Outdoor	Kunststof
Vare nr.	Farve	Pakning
022202	Grå	10 stk.

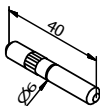

Samle stift

UNI.	Udendørs / Outdoor	AISI 316
Vare nr.	Type	Pakning
022296	Samle stift	8 stk.

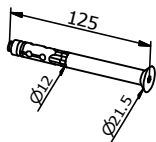

Montage anker

UNI.	Udendørs / Outdoor	Zink - galv.
Vare nr.	L	Pakning
022461	120	25 stk.

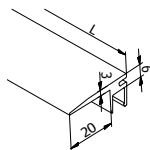

Tilslutningsprofil for gulv

UNI.	Udendørs / Outdoor	Aluminium	
Vare nr.	Type	Længde	Pakning
022279	Gulv profil	2500 mm.	1 stk.
022280	Gulv profil	5000 mm.	1 stk. *Bestillings vare

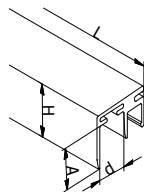

Tilslutningsprofil til 1.0 kN profil.

TL 1500	Udendørs / Outdoor	Aluminium	
Vare nr.	d	Længde	Pakning
022246	3 mm.	2500 mm.	1 stk.
022247	3 mm.	5000 mm.	1 stk. *Bestillings vare
022248	10 mm.	2500 mm.	1 stk.
022249	10 mm.	5000 mm.	1 stk. *Bestillings vare
022250	20 mm.	2500 mm.	1 stk.
022251	20 mm.	5000 mm.	1 stk. *Bestillings vare
022252	120 mm.	2500 mm.	1 stk.
022253	120 mm.	5000 mm.	1 stk. *Bestillings vare

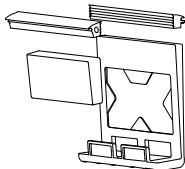

Top-Fix-Kit for 1.0 kN - 2500 mm.

UNI.	Udendørs / Outdoor		
Vare nr.	Farve	Glas	Længde
022316	Black	12 mm.	2500 mm.
022317	Red	66.2	2500 mm.
022320	Green	88.4	2500 mm.
022322	Green	1010.4	2500 mm.

Top-Fix-Kit for 1.0 kN - 5000 mm.

UNI.	Udendørs / Outdoor		
Vare nr.	Farve	Glas	Længde
022323	Black	12 mm.	5000 mm.
022324	Red	66.2	5000 mm.
022327	Green	88.4	5000 mm.
022329	Green	1010.4	5000 mm.

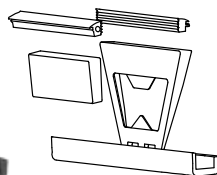

Top-Flex-Kit for 1.0 kN - 2500 mm.

UNI.	Udendørs / Outdoor		
Vare nr.	Farve	Glas	Længde
022346	Black	12 mm.	2500 mm.
022347	Red	66.2	2500 mm.
022350	Green	88.4	2500 mm.
022352	Green	1010.4	2500 mm.

Top-Flex-Kit for 1.0 kN - 5000 mm.

UNI.	Udendørs / Outdoor		
Vare nr.	Farve	Glas	Længde
022356	Black	12 mm.	5000 mm.
022357	Red	66.2	5000 mm.
022359	Green	88.4	5000 mm.
022361	Green	1010.4	5000 mm.



TOP LEVEL 1560

3.0 kN sidemonteret



For projekterende.
beskrivelse til udbudsmateriale.

MAB TOP LEVEL TL1560

3.0 kN Sidemonteret

(vare nr.: 022222)

Linjelast 3.0 kN

(Ø48,3 håndliste: 021260)

(montage anker: 022461)

Secur sikkerhedsglas

MAB secur hærdet lamineret

glas 1212.4 til 1515.4

(21.52 til 31.52 mm.)

Glashøjde

Standard mellem

1000 og 1200 mm.

Kontakt os for DWG tegninger
og specifikke tekniske detaljer.

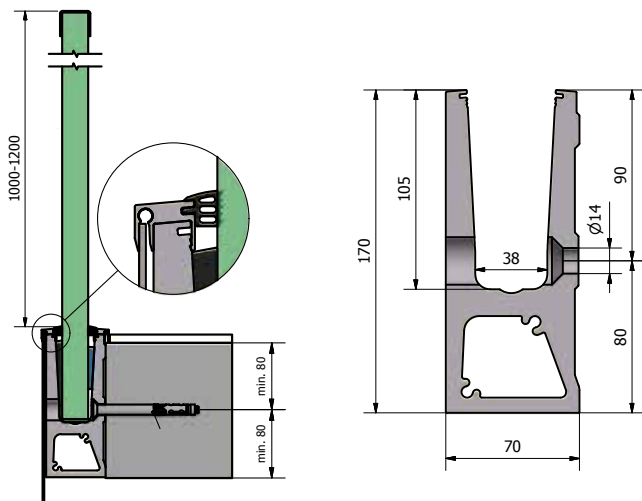

OBS! de angivne kN er forudsat at der er monteret håndliste.

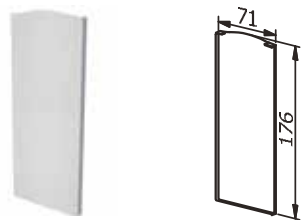
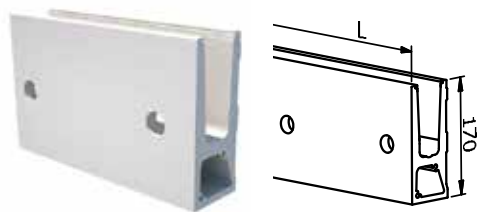

Glasprofil 3.0 kN

TL1560	Udendørs / Outdoor	Aluminium
Vare nr.	Længde	Pakning
022222	2500 mm.	1 stk.

Endeluk

TL1560	Udendørs / Outdoor	Aluminium
Vare nr.	Type	Pakning
022225	Venstre	1 stk.
022226	Højre	1 stk.

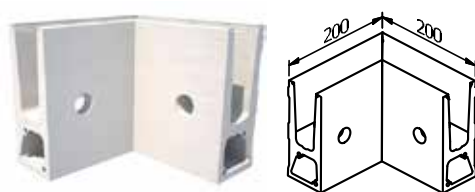
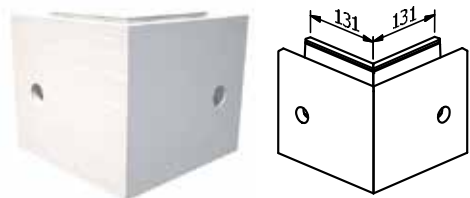

Udvendig hjørne

TL1560	Udendørs / Outdoor	Aluminium
Vare nr.	Pakning	
022224	1 stk.	

Indvendig hjørne

TL1560	Udendørs / Outdoor	Aluminium
Vare nr.	Pakning	
022223	1 stk.	

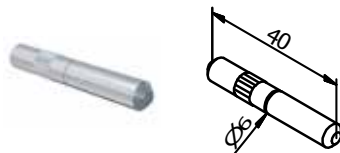

Prop for montage huller

UNI.	Udendørs / Outdoor	PVC
Vare nr.	Farve	Pakning
022202	Grå	10 stk.

Samle stift

UNI.	Udendørs / Outdoor	AISI 316
Vare nr.	Type	Pakning
022296	Samle stift	8 stk.

1

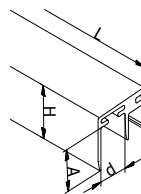
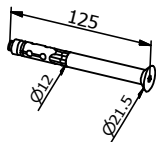

Montage anker

UNI.	Udendørs / Outdoor	Zink - galv.
Vare nr.	L	Pakning
022461	120	25 stk.

Tilslutningsprofil til 3.0 kN profil

TL1500	Udendørs / Outdoor	Aluminium
Vare nr.	d	Længde
022271	3 mm.	2500 mm.
022272	3 mm.	5000 mm.
022273	10 mm.	2500 mm.
022274	10 mm.	5000 mm.
022275	20 mm.	2500 mm.
022276	20 mm.	5000 mm.

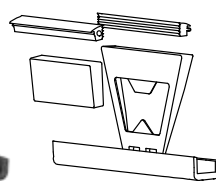
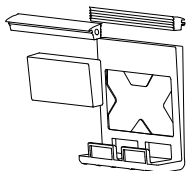

Top-Fix-Kit for 3.0 kN - 2500 mm.

UNI.	Udendørs / Outdoor		
Vare nr.	Farve	Glas	Længde
022380	Red	1010.4	2500 mm.
022381	Grey	1212.4	2500 mm.
022382	Dark Blue	1515.4	2500 mm.

Top-Flex-Kit for 3.0 kN - 2500 mm.

UNI.	Udendørs / Outdoor		
Vare nr.	Farve	Glas	Længde
022353	Red	1010.4	2500 mm.
022354	Grey	1212.4	2500 mm.
022355	Dark Blue	1515.4	2500 mm.

Top-Fix-Kit for 3.0 kN - 5000 mm.

UNI.	Udendørs / Outdoor		
Vare nr.	Farve	Glas	Længde
022330	Red	1010.4	5000 mm
022331	Grey	1212.4	5000 mm.
022332	Dark Blue	1515.4	5000 mm.

Top-Flex-Kit for 3.0 kN - 5000 mm.

UNI.	Udendørs / Outdoor		
Vare nr.	Farve	Glas	Længde
022362	Red	1010.4	5000 mm
022363	Grey	1212.4	5000 mm.
022364	Dark Blue	1515.4	5000 mm.



TOP LEVEL 1570

1.3 kN topmonteret



For projekterende.
beskrivelse til udbudsmateriale.

MAB TOP LEVEL TL1570

1.3 kN Topmonteret
(clamps: 021051 eller 021052)
(montageskinne: 021053)

Linjelast 1.3 kN

(Ø48,3 håndliste: 021260)
(montage anker: 021041 og 021039)

Secur sikkerhedsglas

MAB secur hærdet lamineret
glas 88.4 eller 1010.4
(17.52 til 21.52 mm.)

Glashøjde

Standard mellem
1000 og 1200 mm.

Kontakt os for DWG tegninger
og specifikke tekniske detaljer.

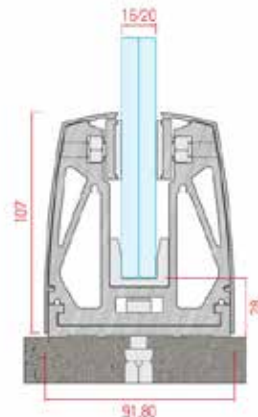

OBS! de angivne kN er forudsat at der er monteret håndliste.



Glas Clamp

TL1570	Udendørs / Outdoor	Aluminium	
Vare nr.	Længde	Glas	Pakning
O21051	150 mm	21,52 mm.	1 stk.
O21052	150 mm.	17,52 mm.	1 stk.

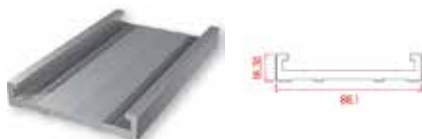

Montageskinne

TL1570	Udendørs / Outdoor	Aluminium	
Vare nr.	Længde	Pakning	
O21053	6000 mm	1 stk.	

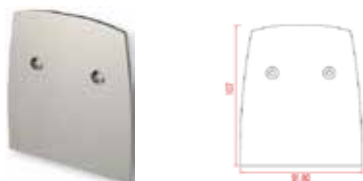

Endeluk

TL1570	Udendørs / Outdoor	Aluminium	
Vare nr.	Pakning		
O21054	1 stk.		



Endeluk

TL1570	Udendørs / Outdoor	Aluminium	
Vare nr.	Glas tykkelse	Pakning	
O21055	17,52 mm.	1 stk.	
O21056	21,52 mm.	1 stk.	



Dækkappe

TL1570	Udendørs / Outdoor	Aluminium	
Vare nr.	Længde	Pakning	
O21057	6000 mm.	1 stk.	



OBS:
gummi tætning er obligatorisk ved brug af 17,52 mm. glas (88,4)

Gummi tætning for cover

TL1570	Udendørs / Outdoor	Gummi	
Vare nr.	Længde	Glas	Pakning
O21058	6000 mm.	17,52 mm.	1 stk.



Montage skrue

TL1570	Udendørs / Outdoor	Zink - galv.	
Vare nr.	L	Pakning	
O21041	70	50 stk.	



Montage anker

TL1570	Udendørs / Outdoor	Zink - galv.	
Vare nr.	Pakning		
O21039	50 stk.		

TOP LEVEL 1590

Piccolo topmonteret



For projekterende.

beskrivelse til udbudsmateriale.

MAB TOP LEVEL TL1590

Topmonteret

(vare nr.: 021050)

Denne type er egnet til af-skærmninger, hvor højden ikke overstiger 600 mm. Ellers skal glasset støttes på siderne eller toppen.

Secur sikkerhedsglas

MAB secur hærdet lamineret glas fra 12 til 66.4

(10 til 13,52 mm.)

Glashøjde

Standard mellem 1000 og 1200 mm.

Kontakt os for DWG tegninger og specifikke tekniske detaljer.

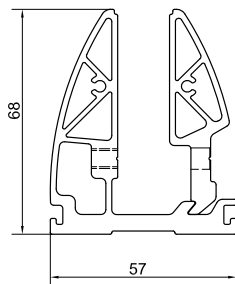

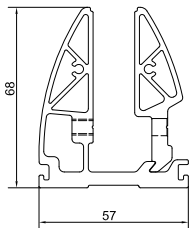

Glas Clamp

TL1590	Udendørs / Outdoor		
Vare nr.	Længde	Glas	Pakning
021050	100 mm	10-10,75 mm	10 stk.

Endeluk

TL1590	Udendørs / Outdoor	
Vare nr.	Pakning	
021048	1 stk.	



Dækkappe

TL1590	Udendørs / Outdoor	
Vare nr.	Længde	Pakning
021047	6000 mm.	1 stk.



Gummisæt

TL1590	Udendørs / Outdoor	
Vare nr.	Glas tykkelse	Pakning
021044	10 - 10.76 mm.	20 stk.
021045	12 - 12.76 mm.	20 stk.
021046	13,52 mm	20 stk.



Super lim

Uni	Udendørs / Outdoor	
Vare nr.	Pakning	
021038	Bruget til fast klæbe gummi 1 stk.	



TL1590 anvendt som vindskærm mellem 2 boliger eller rum. Anvender du frosted glas, har du en flot, privat løsning, til afskærmning med en smuk profilløsning. Kan også anvendes til læskærm på læmure m.v.

TL GLAS CLAMP

Topmonteret



For projekterende.
beskrivelse til udbudsmateriale.

MAB TOP LEVEL GLAS CLAMP Topmonteret

Denne type clamps er anvendelig til alle typer afskærmninger, og værn, hvor der ikke stilles specielle krav.

Secur sikkerhedsglas
MAB secur hærdet lamineret glas fra 12 til 88,4
(12 til 17,52 mm.)

Glashøjde
Standard mellem
1000 og 1200 mm.

Kontakt os for DWG tegninger
og specifikke tekniske detaljer.



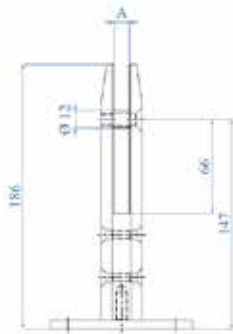

Glas clamp m/plade for topmontage

AISI 316		Udendørs / Outdoor
Vare nr.	Glas tykkelse	Pakning.
022700	12-17,52 mm.	1 stk.

Glas clamp m/plade for topmontage

AISI 304		Indendørs / Indoor
Vare nr.	Glas tykkelse	Pakning.
022701	12-17,52 mm.	1 stk.

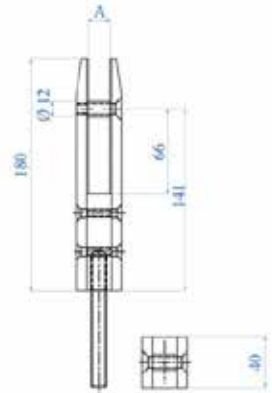

Glas clamp m/M12 gevindstang.

AISI 316		Udendørs / Outdoor
Vare nr.	Glas tykkelse	Pakning.
022702	12-17,52 mm.	1 stk.

Glas clamp m/M12 gevindstang.

AISI 304		Indendørs / Indoor
Vare nr.	Glas tykkelse	Pakning.
022703	12-17,52 mm.	1 stk.

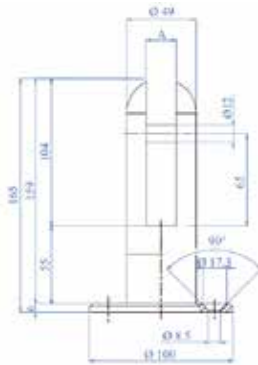

Glas clamp m/plade for topmontage

AISI 316		Udendørs / Outdoor
Vare nr.	Glas tykkelse	Pakning.
022704	12-17,52 mm.	1 stk.

Glas clamp m/plade for topmontage

AISI 304		Indendørs / Indoor
Vare nr.	Glas tykkelse	Pakning.
022705	12-17,52 mm.	1 stk.

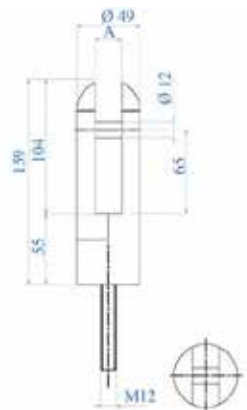

Glas clamp m/M12 gevindstang.

AISI 316		Udendørs / Outdoor
Vare nr.	Glas tykkelse	Pakning.
022706	12-17,52 mm.	1 stk.

Glas clamp m/M12 gevindstang.

AISI 304		Indendørs / Indoor
Vare nr.	Glas tykkelse	Pakning.
022707	12-17,52 mm.	1 stk.

HÅNDLISTE

m/not



Information

Håndliste m/not.

Vi fører håndlister i typerne
Ø42,4 mm. og Ø48,3 mm.

Ud over runde håndlister har
vi også Firkantet 40x60 mm.
og U-profiler 26x20, 30x25 og
40x30 mm.

OBS!

For at de af vore Top Level
profiler med angiven "kN" kan
opfylde kravene, skal der monteres
håndliste på toppen af
glasset. Den eneste der opfylder
kravene er Ø48,3 mm.

Kontakt os for DWG tegninger
og specifikke tekniske detaljer.





Håndliste Ø42,4 mm. m/not

AISI 316	Uden/indendørs - Out/indoor			
Vare nr.	L	D	U	Pakning
021142	5000	42.4	24	1 stk.

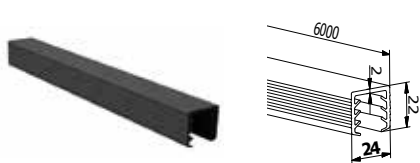

Håndliste gummi

Gummi	Uden/indendørs - Out/indoor		
Vare nr.	U	T	Pakning
022404	24	8-11	6 meter.
022405	24	11,5-13,5	6 meter.
022406	24	15	6 meter.
022407	24	16-17,75	6 meter.
022408	24	19	6 meter.
022409	24	20-21,5	6 meter.

Sælges i længder á 6000 mm.



Håndliste Ø48,3 mm. m/not

AISI 316	Uden/indendørs - Out/indoor			
Vare nr.	L	D	U	Pakning
021260	6000	48.3	27	1 stk.

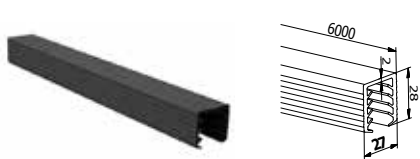

Håndliste gummi

Gummi	Uden/indendørs - Out/indoor		
Vare nr.	U	T	Pakning
022410	27	8-11	6 meter.
022411	27	11,5-13,5	6 meter.
022412	27	15	6 meter.
022413	27	16-17,75	6 meter.
022414	27	19	6 meter.
022415	27	20-21,5	6 meter.

Sælges i længder á 6000 mm.

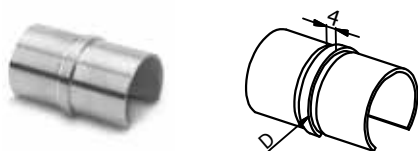

Samlestykke

AISI 316	Uden/indendørs - Out/indoor	
Vare nr.	D	Pakning
021144	42.4 mm.	1 stk.
021263	48.3 mm.	1 stk.



90 gr. hjørne

AISI 316	Uden/indendørs - Out/indoor	
Vare nr.	Ø	Pakning
021146	42.4 mm.	1 stk.
021262	48.3 mm.	1 stk.

1

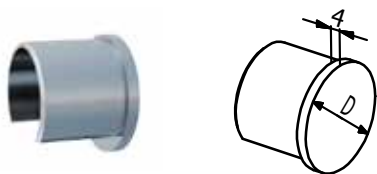

Endeluk

AISI 316 Uden/indendørs - Out/indoor		
Vare nr.	D	Pakning
O21145	42.4 mm.	1 stk.
O21264	48.3 mm.	1 stk.

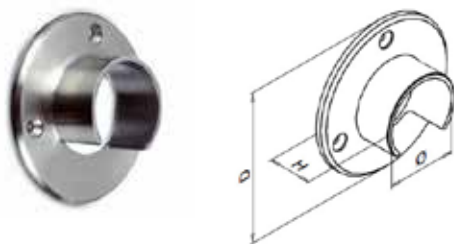

Vægbeslag

AISI 316 Uden/indendørs - Out/indoor				
Vare nr.	Ø	D	H	Pakning
O21152	42.4	90	30	1 stk.
O21265	48.3	95	35	1 stk.

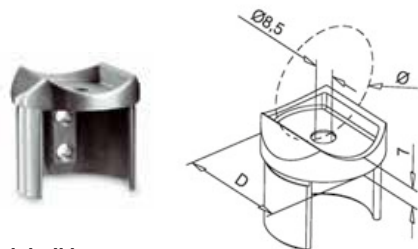

Endeluk til buet rør

AISI 316 Uden/indendørs - Out/indoor		
Vare nr.	Ø	Pakning
O21166	42.4 mm.	1 stk.
O21267	48.3 mm.	1 stk.

MAB
GLASS



Justerbar vinkel m/not "ned"

AISI 316 Uden/indendørs - Out/indoor				
Vare nr.	Ø	H	Vinkel	Pakning.
O21151	42.4 mm.	30 mm.	25-55°	1 stk.



Justerbar vinkel m/not "op"

AISI 316 Uden/indendørs - Out/indoor				
Vare nr.	Ø	H	Vinkel	Pakning.
O21156	42.4 mm.	30 mm.	25-55°	1 stk.

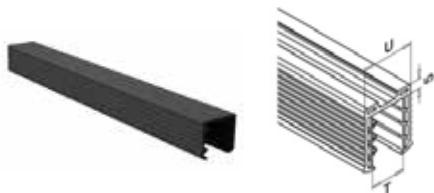
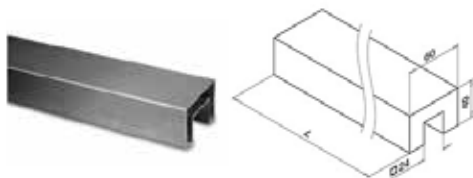

Håndliste

AISI 316	Uden/indendørs - Out/indoor		
Vare nr.	Dimension	Længde	Pakning
021270	40 x 60 x 1,5	5000	1 stk.

Håndliste gummi

Gummi	Uden/indendørs - Out/indoor		
Vare nr.	U	T	Pakning
022404	24	8-11	6000 mm
022405	24	11,5-13,5	6000 mm
022406	24	15	6000 mm
022407	24	16-17,75	6000 mm
022408	24	19	6000 mm
022409	24	20-21,5	6000 mm

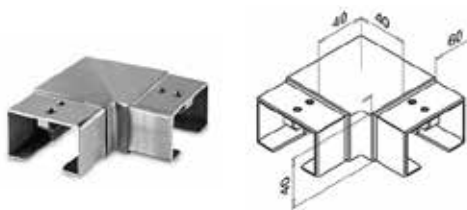
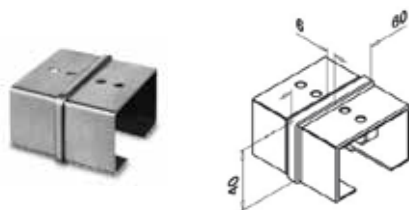

Samlestykke

AISI 316	Uden/indendørs - Out/indoor	
Vare nr.	Dimension	Pakning
021273	40 x 60 x 1,5	1 stk.

90 gr. hjørne

AISI 316	Uden/indendørs - Out/indoor	
Vare nr.	Dimension	Pakning
021272	40 x 60 x 1,5	1 stk.

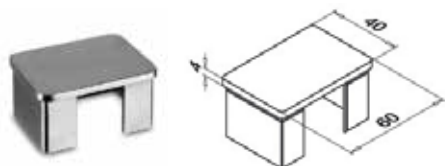

Endeluk

AISI 316	Uden/indendørs - Out/indoor	
Vare nr.	Dimension	Pakning
021274	40 x 60 x 1,5	1 stk.

Vægbeslag

AISI 316	Uden/indendørs - Out/indoor	
Vare nr.	Dimension	Pakning
021277	40 x 60 x 1,5	1 stk.

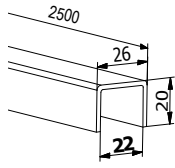

U-Skinne 26x20 mm. (U=22)

AISI 316	Uden/indendørs - Out/indoor			
Vare nr.	BxH	U	længde	Pakning
091100	26x20	22	4000 mm.	1 stk.

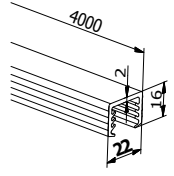

Håndliste gummi U = 22 mm.

Gummi	Uden/indendørs - Out/indoor		
Vare nr.	U	T	Længde
091102	22	11,5-13,5	4000 mm.
091101	22	16-17,75	4000 mm.

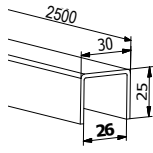

U-Skinne 30x25 mm. (U=26)

AISI 316	Uden/indendørs - Out/indoor			
Vare nr.	BxH	U	længde	Pakning
091104	30x25	26	4000 mm.	1 stk.

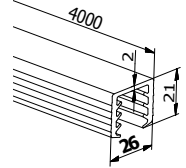

Håndliste gummi U = 26 mm.

Gummi	Uden/indendørs - Out/indoor		
Vare nr.	U	T	Længde
091105	26	11,5-13,5	4000 mm.
091106	26	16-17,75	4000 mm.
091107	26	20-21,5	4000 mm.

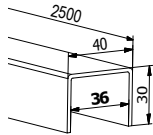

U-Skinne 40x30 mm. (U=36)

AISI 316	Uden/indendørs - Out/indoor			
Vare nr.	BxH	U	længde	Pakning
091120	40x30	36	0000 mm.	1 stk.

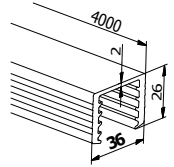

Håndliste gummi U = 36 mm.

Gummi	Uden/indendørs - Out/indoor		
Vare nr.	U	T	Længde
091125	36	24,5-25,5	4000 mm.

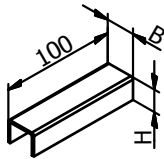

Endeluk u-skinne

AISI 316	Uden/indendørs - Out/indoor			
Vare nr.	BxH	U inv.	Pakning	
091109	26x20	22	1 stk.	
091111	30x25	26	1 stk.	
091121	40x30	36	1 stk.	

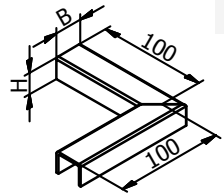

Hjørne 90° u-skinne

AISI 316	Uden/indendørs - Out/indoor			
Vare nr.	BxH	U inv.	Pakning	
091110	26x20	22	1 stk.	
091112	30x25	26	1 stk.	
091122	40x30	36	1 stk.	



Træ håndliste m/not

Træ	Uden/indendørs - Out/indoor				Træ
Vare nr.	Ø	Art	Længde	Pakning	
021153	45	Lærk	Max 3500	1 stk.	
021154	45	Eg	Max 3500	1 stk.	
021197	45	Mahogni	Max 3500	1 stk.	



Montagelim

Lim	Uden/indendørs - Out/indoor			
Vare nr.	Vare	mængde	Pakning	
034204	292 Hvid	290 ml.	1 stk.	
034205	292 Sort	290 ml.	1 stk.	
034212	292 Grå	290 ml.	1 stk.	

INFORMATION TRÆHÅNDLISTE

Ved levering kan bestilte længder af produktions tekniske grunde afvige fra det bestilte. Ved mindre bestillinger bør køber iagttagte dette.

For andre træsorter spørg!

Fingersamling kan tilbydes for at opnå længere håndlister. Standart længder er Max 3500 mm. uden fingersamlinger.

Bemærk at træhåndlister er et naturprodukt, og er et temperatur afhængigt materiale, det skal opbevares tørt og understøttes på hele længden.

Montage!

Der anvendes montagelim i stedet for gummi, da træet kan sprække ved montage med håndliste gummi.

Top Level Montageblok

1

Med montage blokken er det muligt at lave justeringer på Top Level profilen. Det er derfor ikke længere nødvendigt at bore helt nøjagtigt, man har i hver retning en tolerance på +/-5mm.



Top level Combi-tool

Med Top Level **Combi-tool** letter du glasisætning herunder glas justering. Bruges til at flytte og optage kiler, og isætning af gummilister. *Se værktøjet side 62*

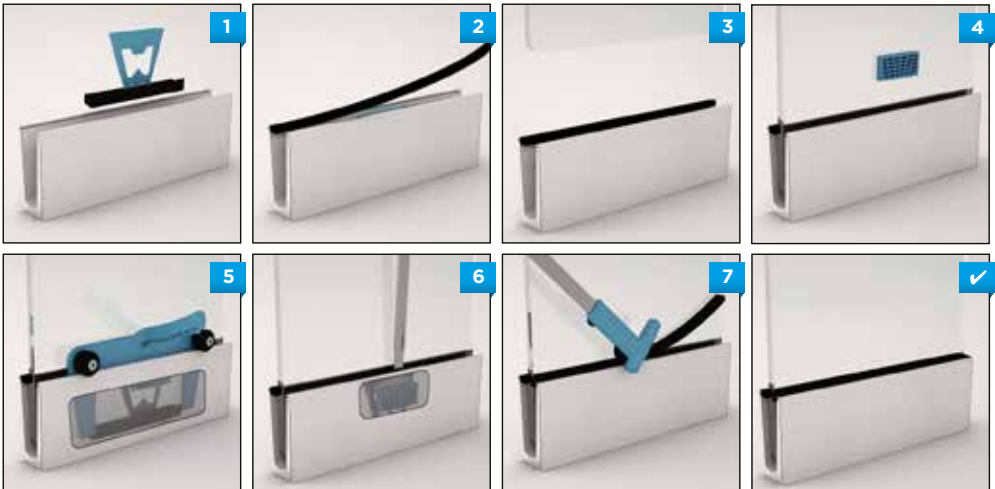

Top level Flex-Fit tool

Til det nye **Top-Flex-Kit** gummisæt, hører et nyt værktøj, **Top-Flex-Kit tool** som gør justering af glas i Top Level profilerne til en leg. Se *værktøjet* side 62

1



Top Level Stift-it samlesystem

Top Level Glas systemerne har **Stift-it** samlesystem til profiler der monteres sammen. Med Top Level **Stift-it** får du centreret glasfals, montage af Secur Top Level glas sker korrekt. **Stift-it** er udført i 316 Rustfrit stål, velegnet til anvendelse i alle miljøer, bestilles under varenr. 022296



Top Level drænhuller

Vind, Vand, Temperaturforskelle nødvendiggør, at vand skal afledes kontrolleret fra profilens bundfals, her under er vist et eksempel hvor dan en profil er drænet. Såvel konstruktor som montør, skal kontrollere at dræn fungerer som anbefalet.



1



Top-Flex-Kit værktøj

Værktøj	
Vare nr.	Type
022530	Bruges til Top-Flex-Kit gummisæt

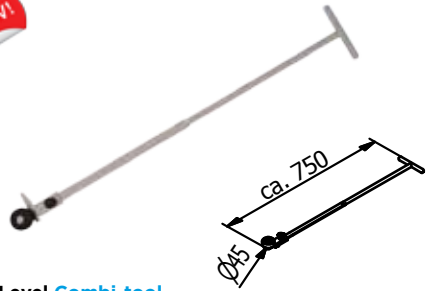

Top Level Combi-tool

Værktøj	
Vare nr.	Type
022520	Isætning af gummi og kiler, og fjernelse af kiler



Fuge pistol

Værktøj	
Vare nr.	Type
022526	Fuge pistol



Lim for montage ankre

Lim	
Vare nr.	Type
022525	Lim for montage ankre



Luftpumpe

Værktøj	
Vare nr.	Type
022527	Luft pumpe



Lim for håndlister osv.

Lim	
Vare nr.	Type
033331	Lim til rustfri stål og aluminium



Top Level 1530
vare nr.: 022560



Top Level 1530
vare nr.: 022561



Top Level 1530
vare nr.: 022562



Top Level 1530
vare nr.: 022563



Top Level 1550
vare nr.: 022564



Top Level 1560
vare nr.: 022565



Top Level 1560
vare nr.: 022566



Top Level 1560
vare nr.: 022567



Top Level 1560
vare nr.: 022568

Udstillings displays

Display	
Vare nr.	Type
022560	TL1530 Top monteret 1.0 kN
022561	TL1530 Top monteret 3.0 kN
022562	TL1530 Side monteret 1.0 kN
022563	TL1530 Side monteret 3.0 kN

Udstillings displays

Display	
Vare nr.	Type
022564	TL1550 Top monteret 1.0 kN
022565	TL1560 Top monteret 1.0 kN
022566	TL1560 Top monteret 3.0 kN
022567	TL1560 Side monteret 1.0 kN
022568	TL1560 Side monteret 3.0 kN

MAB GLAS SKANDINAVIEN

dit sikre valg!

MAB GLAS SKANDINAVIEN
Ulvevej 13
DK-7800 Skive
Danmark

Tlf.: +45 9752 6533
Fax: +45 9752 1622
info@mabglas.dk
www.mabglas.dk

