



## TOP RAILING

Glasværn

Gelændersystemer



## MAB TOP RAILING SYSTEM

*-en rigtig løsning til ethvert formål!*

Top Railing Systemerne er det rigtige produkt valg, til alle værn løsninger, hvor æstetik, flot udseende, og nødvendigt sikkerhed skal opfyldes.

2

Konceptet er baseret på et modul-system, der er let at montere og samle uden svejsning. Det er derfor også let at adskille i tilfælde af reparation eller ombygning.

Vi fremstiller også kundetilpassede designløsninger. MAB Glas Skandinavien rådgiver gerne vedrørende tekniske detaljer, projektforslag og tilbud. Det færdige gelænder leveres parat til montering.

Gennemført design og kvalitet. Der anvendes rustfri stål RSS 304 og 316L som stål kvalitet.

Med brochuren vælger du udseende og montageprincip.

- Har du spørgsmål til det rigtige valg, kontakt vor salgsafdeling.
- [info@mabglas.dk](mailto:info@mabglas.dk)
- Tlf.: +45 9752 6533

Top Railing system..Nemt og bekvemt!





## Topmonteret poste

AISI 316		Udendørs / Outdoor
Vare nr.	Ø	H
033000	42,4	925
033002	42,4	1000
033004	42,4	1200

## Topmonteret poste m/håndliste holder

AISI 316		Udendørs / Outdoor
Vare nr.	Ø	H
033006	42,4	1000
033008	42,4	1200



## Side monteret poste uden beslag

AISI 316		Udendørs / Outdoor
Vare nr.	Ø	H
033010	42,4	1125
033810	42,4	1200

## Side monteret poste m/håndliste holder.

AISI 316		Udendørs / Outdoor
Vare nr.	Ø	H
033012	42,4	1200

⚠ OBS! sidemonterede poste uden beslag, husk håndlisteholder (eks.: 033107) og endeluk til bunden (eks.: 033164) evt. clamps (eks.: 033273)

# TOP RAILING

## Top eller sidemonteret

2



### For projekterende.

beskrivelse til udbudsmateriale.

#### MAB TOP RAILING

Top eller Sidemonteret

Rør Ø42,4 mm.

(håndliste: 033183)

(montage skruer: 033469)

(montage anker: 033445)

#### Secur sikkerhedsglas

MAB secur hærdet lamineret  
glas 44.2 (8.76 mm.)

(ved anvendelse af 033276 kan 55.2

(10.76 mm. glas anvendes)

#### Glashøjde

Standard mellem  
850 og 1000 mm.

Kontakt os for DWG tegninger  
og specifikke tekniske detaljer.

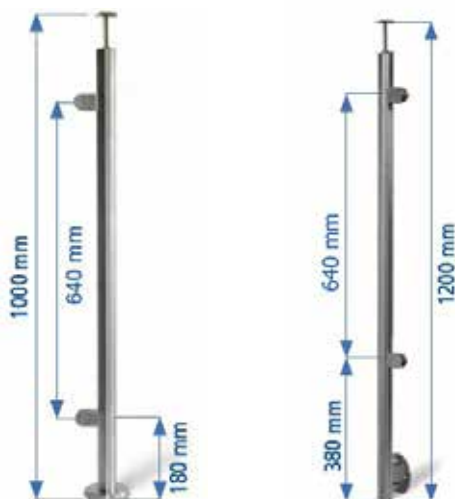

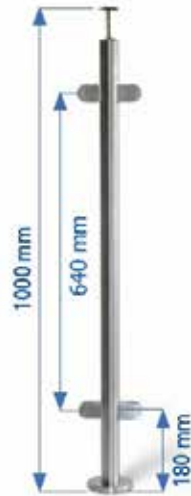
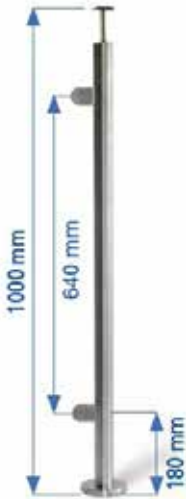

## Enkelt poste

AISI 316		Udendørs / Outdoor	
Vare nr.	Ø	H	Håndliste
033014	42,4	1000	fast
033016	42,4	1000	justerbar

## Dobbelt poste

AISI 316		Indendørs / Indoor	
Vare nr.	Ø	H	Håndliste
033018	42,4	1000	fast
033020	42,4	1000	justerbar



## 90° graders hjørne poste

AISI 316		Udendørs / Outdoor	
Vare nr.	Ø	H	Håndliste
033022	42,4	1000	fast





## Poste uden dobbelt

AISI 316		Udendørs / Outdoor	
Vare nr.	Ø	L	håndliste
033024	42,4	1200	fast
033026	42,4	1200	justerbar



## Poste enkelt højre

AISI 316		Udendørs / Outdoor	
Vare nr.	Ø	L	håndliste
033028	42,4	1200	fast
033030	42,4	1200	justerbar



## Poste enkelt venstre

AISI 316		Udendørs / Outdoor	
Vare nr.	Ø	L	håndliste
033032	42,4	1200	fast
033034	42,4	1200	justerbar

MAB  
GLASS



## Poste 90° udvendig hjørne

AISI 316			
Vare nr.	Ø	H	håndliste
033090	42,4	1200	fast



## Poste 90° indvendig hjørne

AISI 316			
Vare nr.	Ø	H	håndliste
033092	42,4	1200	fast

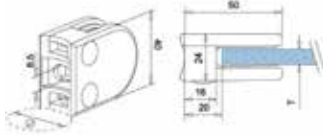

## Sikkerheds stift for glasbeslag 033273.

AISI 316		Udendørs / Outdoor	
Vare nr.	Type	Hul i glas	Pakning
033277	Sikkerheds stift	Ø10 mm.	10 stk.



## Klembeslag

AISI 316		Udendørs / Outdoor	
Vare nr.	Glas tykkelse	Type	Pakning
033273	8-8,76 mm.	Ø42,4	4 stk.
033274	8-8,76 mm.	Flad bag	4 stk.

## Gummi sæt til clamp 033273

AISI 316		Udendørs / Outdoor	
Vare nr.	Glas	Pakning	
033275	8-8,76 mm.	2 stk.	
033276	10-10,76 mm.	2 stk.	

# TOP RAILING

m/rørholdere for 10 eller 12 mm.

2







## Poste med rørholdere

AISI 316		Udendørs / Outdoor			
Vare nr.	Ø	Y	A	håndliste	
033038	42,4	180	5 stk. Ø12	fast	
033040	42,4	134	7 stk. Ø12	fast	
033042	42,4	180	5 stk. Ø10	fast	
033044	42,4	134	7 stk. Ø10	fast	

## Poste med rørholdere

AISI 316		Udendørs / Outdoor			
Vare nr.	Ø	Y	A	håndliste	
033048	42,4	180	5 stk. Ø12	justerbar	
033050	42,4	134	7 stk. Ø12	justerbar	
033052	42,4	180	5 stk. Ø10	justerbar	
033054	42,4	134	7 stk. Ø10	justerbar	



## Poste med rørholdere 90° hjørne

AISI 316		Udendørs / Outdoor			
Vare nr.	Ø	Y	A	håndliste	
033058	42,4	180	5 stk. Ø12	fast	
033060	42,4	134	7 stk. Ø12	fast	
033062	42,4	180	5 stk. Ø10	fast	
033064	42,4	134	7 stk. Ø10	fast	

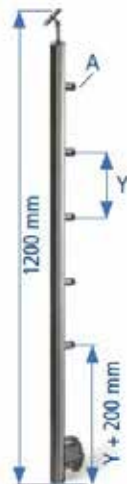

## Poste med rørholdere

AISI 316	Udendørs / Outdoor			
Vare nr.	Ø	Y	A	håndliste
033078	42,4	180	5 stk. Ø12	fast
033080	42,4	134	7 stk. Ø12	fast
033082	42,4	180	5 stk. Ø10	fast
033084	42,4	134	7 stk. Ø10	fast

## Poste med rørholdere m/ justerbar håndlisteholdere

AISI 316	Udendørs / Outdoor			
Vare nr.	Ø	Y	A	håndliste
033068	42,4	180	5 stk. Ø12	justerbar
033070	42,4	134	7 stk. Ø12	justerbar
033072	42,4	180	5 stk. Ø10	justerbar
033074	42,4	134	7 stk. Ø10	justerbar

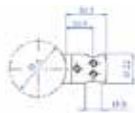

## Rør holder samle beslag

AISI 316	Udendørs / Outdoor	
Vare nr.	Ø A	Ø B
033321	42,4	10,2
033323	42,4	12,2

## Rør holder enkelt

AISI 316	Udendørs / Outdoor	
Vare nr.	Ø A	Ø B
033317	42,4	10,2
033319	42,4	12,2



# TOP RAILING

## Fittings

2



# Top Railing fittings

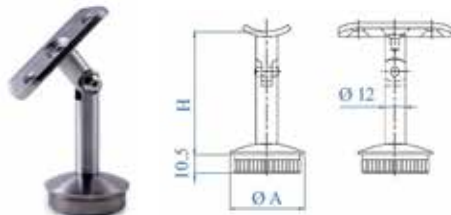
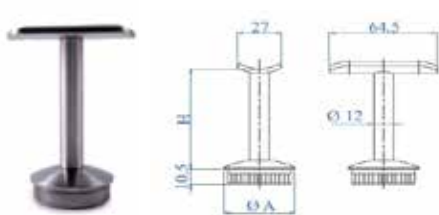

2

## Håndliste holder lige

AISI 316		Udendørs / Outdoor
Vare nr.	Ø A	Højde (H)
033101	42.4	75

## Håndliste holder justerbar

AISI 316		Udendørs / Outdoor
Vare nr.	Ø A	Højde (H)
033103	42.4	75

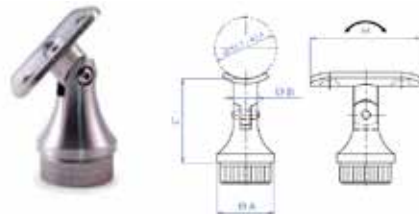

## Håndliste holder lige

AISI 316		Udendørs / Outdoor
Vare nr.	Ø A	Højde (H)
033109	42.4	58

## Håndliste holder justerbar

AISI 316		Udendørs / Outdoor
Vare nr.	Ø A	Højde (H)
033111	42.4	58



## Håndliste holder lige

AISI 316		Udendørs / Outdoor
Vare nr.	Ø A	Højde (H)
033105	42.4	88

## Håndliste holder justerbar

AISI 316		Udendørs / Outdoor
Vare nr.	Ø A	Højde (H)
033107	42.4	88



Håndliste holder justerbar højde

AISI 316		Udendørs / Outdoor
Vare nr.	Ø A	Højde (H)
033112	42.4	justerbar

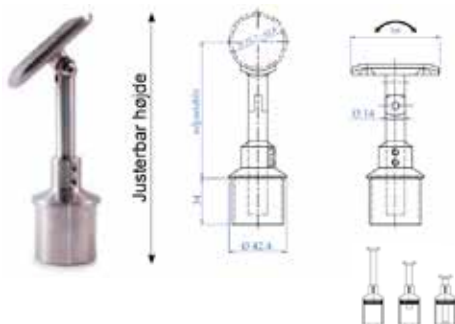

Håndliste holder justerbar højde og vinkel

AISI 316		Udendørs / Outdoor
Vare nr.	Ø A	Højde (H)
033113	42.4	justerbar



Top 45° graders

AISI 316		Udendørs / Outdoor
Vare nr.	Type	
033141	45° graders	



Top 90° graders

AISI 316		Udendørs / Outdoor
Vare nr.	Type	
033143	90° graders	

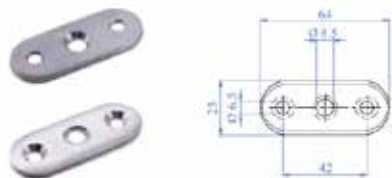

Top flad

AISI 316		Udendørs / Outdoor
Vare nr.	Type	
033145	flad	

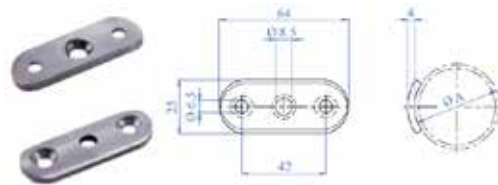

Top lige

AISI 316		Udendørs / Outdoor
Vare nr.	Ø	Type
033147	42,4	Lige

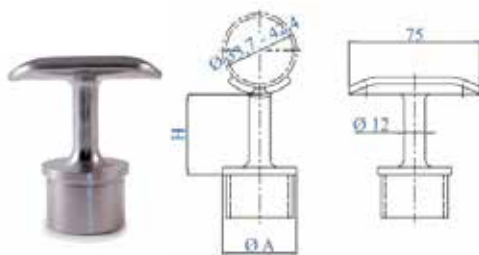

## Håndlistestøtte 50 mm.

AISI 316		Udendørs / Outdoor	
Vare nr.	Ø A	Højde (H)	
033115	42.4	50 mm.	

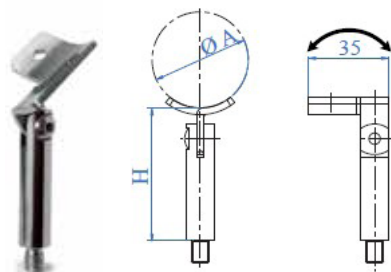

## Håndlistestøtte justerbar enkel

AISI 316		Udendørs / Outdoor	
Vare nr.	Ø A	Højde (H)	
033117	42.4	58 mm.	



## Håndlistestøtte lige

AISI 316		Udendørs / Outdoor	
Vare nr.	Ø A	Højde (H)	
033121	42.4	64 mm.	



## Håndlistestøtte justerbar

AISI 316		Udendørs / Outdoor	
Vare nr.	Ø A	Højde (H)	
033123	42.4	65 mm.	

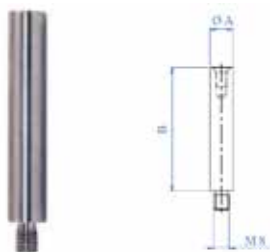

## Stang lige

AISI 316		Udendørs / Outdoor	
Vare nr.	Ø (A)	Højde (B)	
033125	12	65 mm.	
033127	12	115 mm.	



## Stang justerbar

AISI 316		Udendørs / Outdoor	
Vare nr.	Ø (A)	Højde (B)	
033129	12	65mm.	



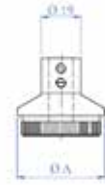

2

## Stang

AISI 316	Udendørs / Outdoor	
Vare nr.	Ø (A)	(B)
033151	12	80
033153	12	115

## Endeluk justerbar

AISI 316	Udendørs / Outdoor	
Vare nr.	Ø (A)	Anvendes sammen med:
033161	42,4	033151 og 033153

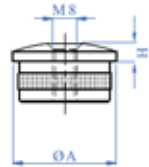
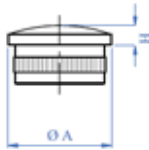

## Endeluk afrundet

AISI 316	Udendørs / Outdoor	
Vare nr.	Ø (A)	H
033158	42,4	9

## Endeluk afrundet med M8 gevind

AISI 316	Udendørs / Outdoor	
Vare nr.	Ø (A)	H
033159	42,4	7

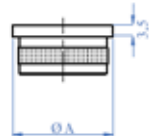
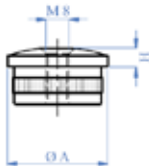

## Endeluk afrundet med M8 gevind

AISI 316	Udendørs / Outdoor	
Vare nr.	Ø (A)	H
033162	42,4	9

## Endeluk flad

AISI 316	Udendørs / Outdoor	
Vare nr.	Ø (A)	
033164	42,4	



# Top Railing fittings

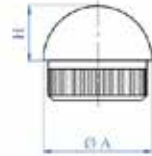
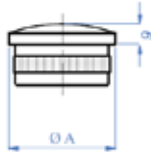

2

## Endeluk afrundet

AISI 316		Udendørs / Outdoor
Vare nr.	Ø (A)	
033166	42,4	

## Endeluk afrundet

AISI 316		Udendørs / Outdoor
Vare nr.	Ø (A)	H
033169	42,4	20

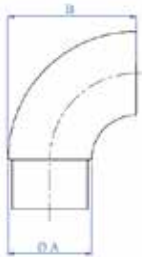

## Endeluk 90° rund

AISI 316		Udendørs / Outdoor
Vare nr.	Ø (A)	B
033328	42,4	55

## Endeluk afrundet

AISI 316		Udendørs / Outdoor
Vare nr.	Ø (A)	
033199	12	

# Top Railing fittings

2



## Vægbeslag

AISI 316	Udendørs / Outdoor	
Vare nr.	Ø (A)	
033131	42,4	



## Montage ring for ekstra håndliste

AISI 316	Udendørs / Outdoor	
Vare nr.	Ø	Gevind
033229.1	42,4	M6

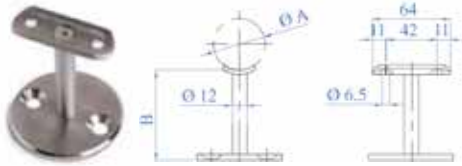

## Topbeslag for Ø42

AISI 316	Udendørs / Outdoor	
Vare nr.	Ø (A)	B
033243	42,4	50
033245	42,4	100

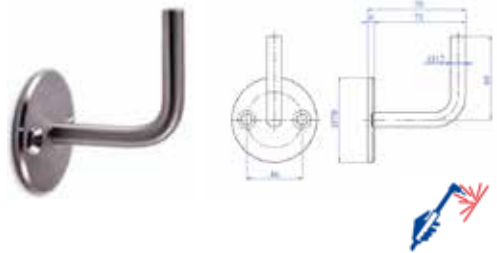

## Vægbeslag til påsvejsning

AISI 316	Udendørs / Outdoor	
Vare nr.	Ø (A)	
033241	42,4	



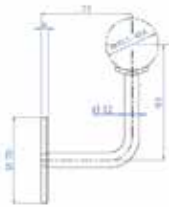

## Vægbeslag

AISI 316		Udendørs / Outdoor
Vare nr.	Ø (A)	
033171	42,4	

## Vægbeslag justerbar

AISI 316		Udendørs / Outdoor
Vare nr.	Ø (A)	
033173	42,4	

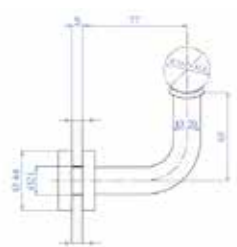
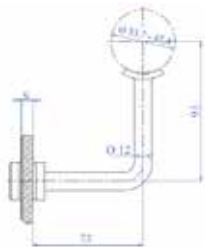

## Glas montage

AISI 316		Udendørs / Outdoor
Vare nr.	Ø (A)	S
033181	42,4	8-22

## Glas montage

AISI 316		Udendørs / Outdoor
Vare nr.	Ø (A)	S
033177	42,4	8-22

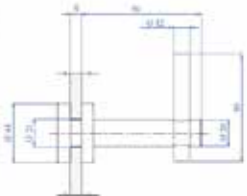

## Vægbeslag

AISI 316		Udendørs / Outdoor
Vare nr.	Ø (A)	
033179	42,4	

## Glas montage

AISI 316		Udendørs / Outdoor
Vare nr.	Ø (A)	S
033229	42,4	8-22

2



## Rør Ø42.4 mm. 6000 mm.

AISI 316		Udendørs / Outdoor	
Vare nr.	Ø	Længde	Tykkelse
033183	42,4	6000 mm.	2 mm.

## Rør 42.4 mm. 5000 mm.

AISI 316		Udendørs / Outdoor	
Vare nr.	Ø	Længde	Tykkelse
033183.1	42,4	5000 mm.	2 mm.



## Rør Ø12 mm.

AISI 316		Udendørs / Outdoor	
Vare nr.	Ø	Længde	Tykkelse
033185	12	6000 mm.	0,5 mm.
033187	12	6000 mm.	1,5 mm.



## Rør (masiv) Ø12 mm.

AISI 316		Udendørs / Outdoor	
Vare nr.	Ø	Længde	
033195	12	6000 mm.	

## Rør (masiv) Ø10 mm.

AISI 316		Udendørs / Outdoor	
Vare nr.	Ø	Længde	
033191	10	6000 mm.	

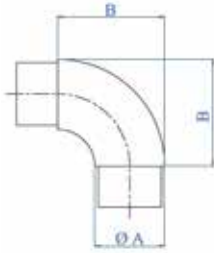

## 90° Hjørne rund

AISI 316		Udendørs / Outdoor
Vare nr.	Ø (A)	B
033201	42,4	65

## 90° Hjørne vinkel

AISI 316		Udendørs / Outdoor
Vare nr.	Ø (A)	B
033203	42,4	65

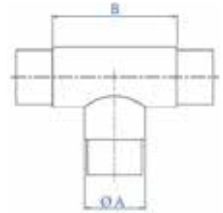

## 45° Hjørne

AISI 316		Udendørs / Outdoor
Vare nr.	Ø (A)	B
033204	42,4	50

## Samlestykke T-model

AISI 316		Udendørs / Outdoor
Vare nr.	Ø (A)	B
033206	42,4	87

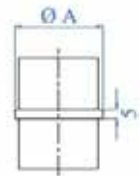

## Samlestykke 3-vejs hjørne

AISI 316		Udendørs / Outdoor
Vare nr.	Ø (A)	B
033207	42,4	70

## Samle stykke

AISI 316		Udendørs / Outdoor
Vare nr.	Ø (A)	
033209	42,4	

2

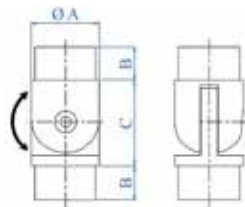

## Justerbar hjørne

AISI 316		Udendørs / Outdoor	
Vare nr.	Model	Ø	H
033264	"NY"	42,4	28

## Justerbar samle led

AISI 316		Udendørs / Outdoor		
Vare nr.	Ø (A)	B	C	
033208	42,4	22	53	

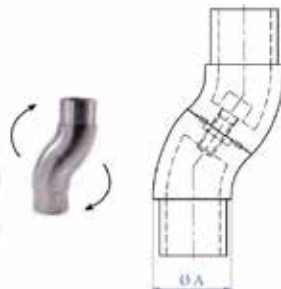
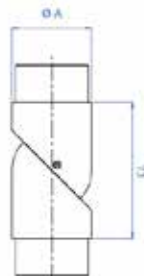

## Justerbar hjørne

AISI 316		Udendørs / Outdoor	
Vare nr.	Ø (A)		
033211	42,4		

## Justerbar samle led

AISI 316		Udendørs / Outdoor	
Vare nr.	Ø (A)		
033205	42,4		

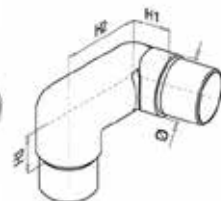
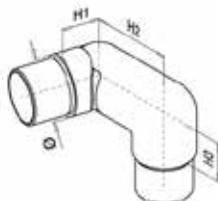

## Justerbar hjørne 0-70° højre

AISI 316		Udendørs / Outdoor			
Vare nr.	Model	Ø	H1	H2	H3
033262	0 - 70°	42,4	27	60	30

## Justerbar hjørne 0-70° venstre

AISI 316		Udendørs / Outdoor			
Vare nr.	Model	Ø	H1	H2	H3
033263	0 - 70°	42,4	27	60	30

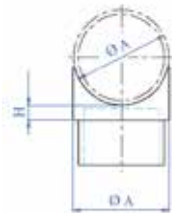
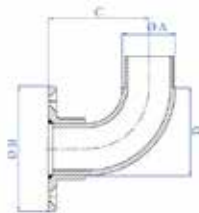

## Vægmontage 90°

AISI 316		Udendørs / Outdoor			
Vare nr.	Ø (A)	B	C	D	
033212	42,4	84	84	65	

## Vægmontage 90°

AISI 316		Udendørs / Outdoor	
Vare nr.	Ø (A)	H	
033213	42,4	12	

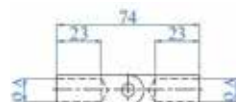
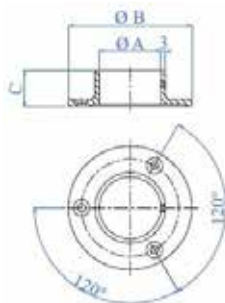

## Vægmontageplade

AISI 316		Udendørs / Outdoor	
Vare nr.	Ø (A)	B	C
033214	42,4	84	25

## Justerbart sameled

AISI 316		Udendørs / Outdoor	
Vare nr.	Ø (A)		
033340	12 mm.		
033341	10 mm.		



2

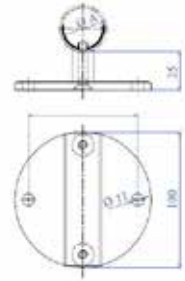
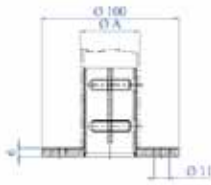

## Top monteret fod

AISI 316		Udendørs / Outdoor
Vare nr.	Ø (A)	
033216	42,4	

## Side monteret fod

AISI 316		Udendørs / Outdoor
Vare nr.	Ø (A)	
033218	42,4	

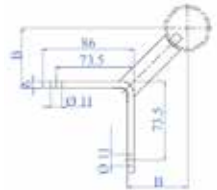
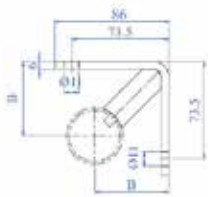

## Side monteret indvendighjørne fod

AISI 316			Udendørs / Outdoor
Vare nr.	Ø (A)	B	
033220	42,4	56	

## Side monteret udvendighjørne fod

AISI 316			Udendørs / Outdoor
Vare nr.	Ø (A)	B	
033222	42,4	56	



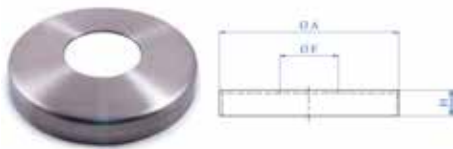

## Dækkappe

AISI 316	Udendørs / Outdoor		
Vare nr.	Ø (A)	F (Ø)	H
033231	76	12,5	12
033233	76	14,5	12
033235	85	43	15
033237	105	43	15
033239	105	43	25

## Fodplade for på skruring

AISI 316	Udendørs / Outdoor	
Vare nr.	Ø (A)	Huller
033248	100	3 x Ø9 mm.



## Rør indsats

Alu	Udendørs / Outdoor	
Vare nr.	Ø (A)	M
033247	38	10 x 40

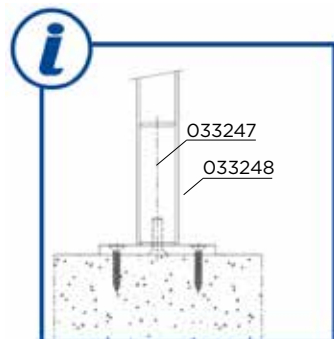

## Topmonteret fod til påsvejsning

AISI 316	Udendørs / Outdoor	
Vare nr.	Ø (A)	
033223	100	

2

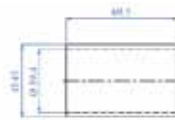

## Træ håndliste

TRÆ	Indendørs / Indoor		
Vare nr.	Ø	Type	Længde
021245	45	Mahogni	Max 4000 mm.
021246	45	Eg	Max 4000 mm.
021247	45	Teak	Max 4000 mm.

OBS! Andre træ sorter kan også leveres.



## Samlestykke lige model

AISI 303	Indendørs / Indoor	
Vare nr.	Ø (A)	
033250	45	

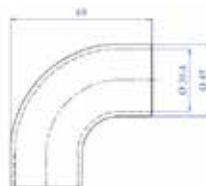

## Samlestykke T-model

AISI 303	Indendørs / Indoor	
Vare nr.	Ø (A)	
033251	45	

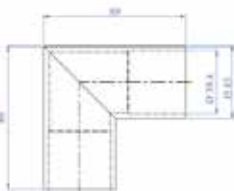

## 90° Graders hjørne

AISI 303	Indendørs / Indoor	
Vare nr.	Ø (A)	
033252	45	

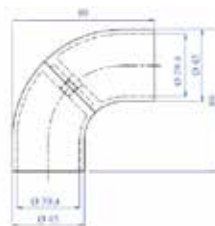

## 90° Graders vinkel hjørne

AISI 303	Indendørs / Indoor	
Vare nr.	Ø (A)	
033253	45	

## Justerbart samle led

AISI 303	Indendørs / Indoor	
Vare nr.	Ø (A)	
033254	45	

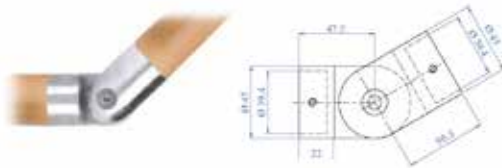

## Justerbart samle led

AISI 303		Indendørs / Indoor
Vare nr.	Ø (A)	
033255	45	

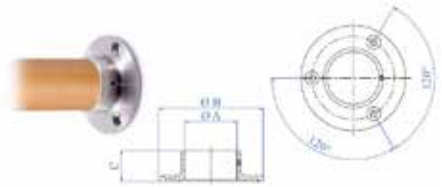

## Vægmontageplade

AISI 303		Indendørs / Indoor		
Vare nr.	A (Ø)	B (Ø)	C	
033256	45	95	29	



## Endekappe flad

AISI 303		Indendørs / Indoor
Vare nr.	Ø (A)	
033257	45	



## Endekappe rund

AISI 303		Indendørs / Indoor		
Vare nr.	Ø (A)			
033258	45			

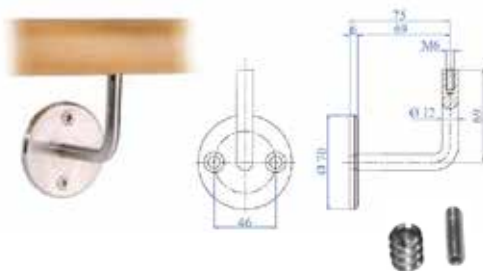

## Vægbeslag uden top, monteres i træet.

AISI 303		Indendørs / Indoor
Vare nr.	Ø	
033259	40	

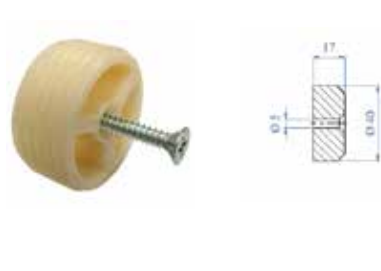

## Plastic beslag, til endepapper og samleled.

Plastic		Indendørs / Indoor
Vare nr.	Ø	
033260	40	

2



## Bore skabelon

Værktøj	skabelon / tool
Vare nr.	Anvendelse
033272	Håndlister 42,4 og Ø48,3 mm.

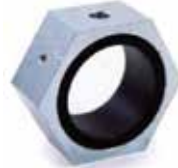

## Skabelon for montage af plastic beslag

Værktøj	skabelon / tool
Vare nr.	Anvendelse
033270	Træhåndlister Ø45 mm.

## Bore skabelon til håndlister Ø45

Værktøj	skabelon / tool
Vare nr.	Anvendelse
033271	

# INFORMATION NEM MONTAGE MED SKABELON

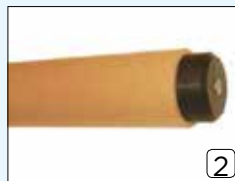



# TOP RAILING

Wire on post system

2



# Top Railing wire on post system



## Wire

AISI 316		Udendørs / Outdoor	
Vare nr.	Ø	kN	
033430	6 mm.	20	

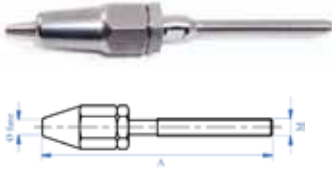

## Wire kobling

AISI 316		Udendørs / Outdoor		
Vare nr.	M	A	Møtrik	
033433	6M	119 mm.	M12	

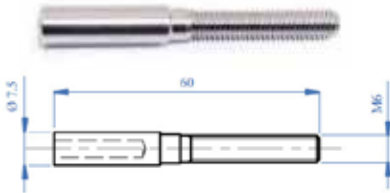

## Wire klips

AISI 316		Udendørs / Outdoor	
Vare nr.	M	Gevind	
033442	6M	Venstre	
033443	6M	Højre	

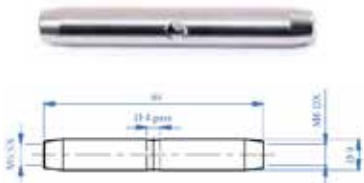

## Samlestykke

AISI 316		Udendørs / Outdoor	
Vare nr.	M	Gevind	
033437	6M	Venstre/Højre	

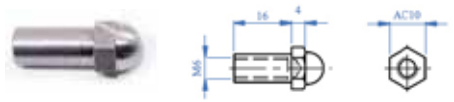

## Møtrik

AISI 316		Udendørs / Outdoor	
Vare nr.	Gevind		
033431	Højre		
033432	Venstre		



## Skrue

AISI 316		Udendørs / Outdoor	
Vare nr.	Gevind	M	
033434	Højre	M6	
033435	Venstre	M6	



## Vinkel bøjning

AISI 316		Udendørs / Outdoor	
Vare nr.	M		
033435	6M		

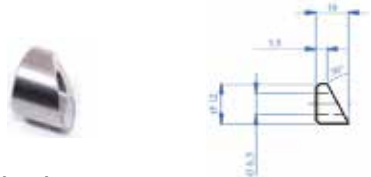

## Vinkel bøsning

AISI 316		Udendørs / Outdoor	
Vare nr.			
033438			

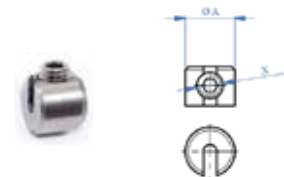

## Wire stopper

AISI 316		Udendørs / Outdoor	
Vare nr.			
033439			



# TOP RAILING

Kubic system

2





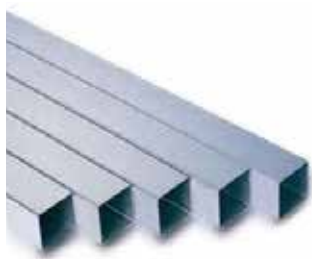

## Firkant rør

AISI 316	Udendørs / Outdoor	
Vare nr.	Ø (A)	
033354	40 x 40 x 2,0 x 6000 mm.	



## 90° Hjørne

AISI 316	Udendørs / Outdoor	
Vare nr.	A	B
033363	40	25

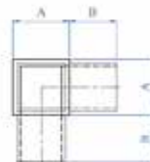

## Samlestykke T-model

AISI 316	Udendørs / Outdoor	
Vare nr.	A	B
033367	40	25

## Samlestykke 3-vejs hjørne

AISI 316	Udendørs / Outdoor	
Vare nr.	A	B
033371	40	25

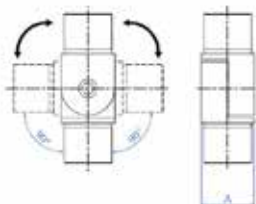

## Justerbart samlestykke

AISI 316	Udendørs / Outdoor	
Vare nr.	A	
033373	40	

2

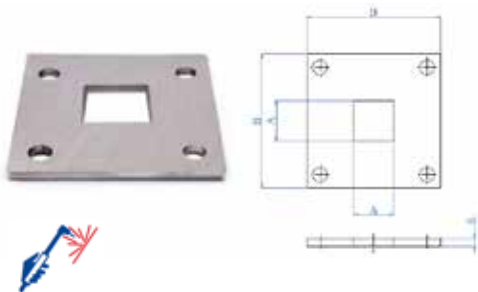

## Beslag til på svejsning

AISI 316		Udendørs / Outdoor	
Vare nr.	A	B	
033379	40	100	



## Sidemonteret fod

AISI 316		Udendørs / Outdoor	
Vare nr.	A		
033381	40		

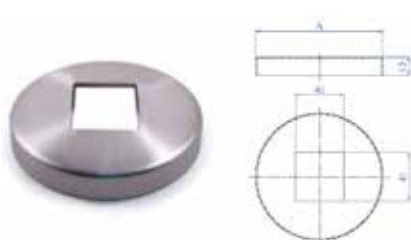

## Dækkappe rund/firkantet

AISI 316		Udendørs / Outdoor	
Vare nr.	A (Ø)		
033383	105		

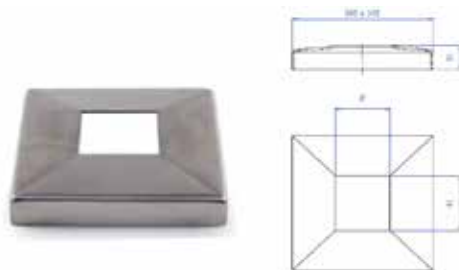

## Dækkappe firkantet

AISI 316		Udendørs / Outdoor	
Vare nr.	F	H	
033385	41	15	

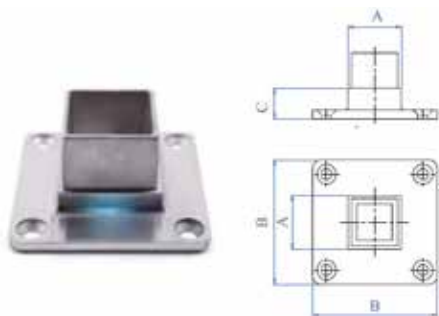

## Montage plade

AISI 316		Udendørs / Outdoor		
Vare nr.	A	B	C	
033377	40	80	18	

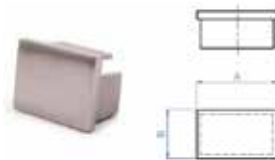
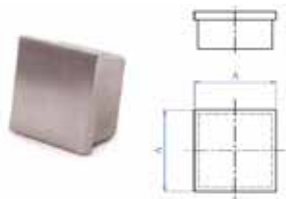

## Endeluk

AISI 316		Udendørs / Outdoor
Vare nr.	A	
033393	30	

## Endeluk

AISI 316		Udendørs / Outdoor
Vare nr.	A	B
033395	40	20



## Håndliste holder lige

AISI 316		Udendørs / Outdoor	
Vare nr.	F	H	Håndliste
033403	40	75	Ø 42,4

## Håndliste holder Justerbar

AISI 316		Udendørs / Outdoor	
Vare nr.	F	H	Håndliste
033407	40	75	Ø 42,4

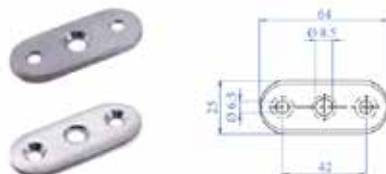
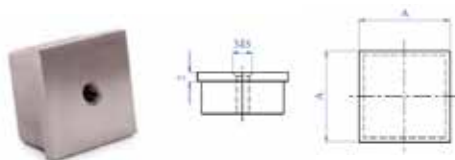

## Endeluk M8 gevind

AISI 316		Udendørs / Outdoor
Vare nr.	F	Håndliste
033411	40	Ø 42,4

## Top lige flad

AISI 316		Udendørs / Outdoor
Vare nr.	F	Håndliste
033145	40	Flad

# TOP RAILING

## B-Inox serie 100

2



### For projekterende.

beskrivelse til udbudsmateriale.

#### MAB TOP RAILING B-inox serie 100

- Top eller Sidemonetert
- Rustfri stål stolper fremstillet i 50x12 mm. stål.
- Højde 1000, 1100 eller 1200 mm.
- Børstet eller blank overflade.
- Max afstand mellem septre 1200 mm.

Kontakt os for DWG tegninger og specifikke tekniske detaljer.

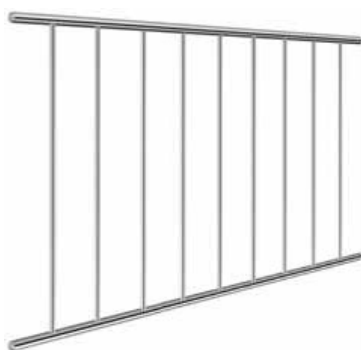

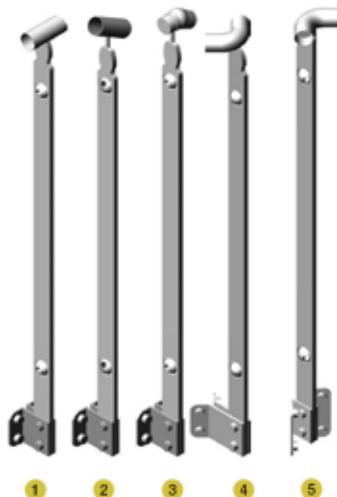
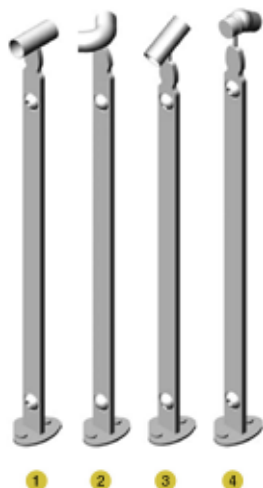

2

## Top monteret

Rustfri	Ude/Indendørs	
Vare nr.	Nr.	Type
021100	1	For vandret montage
	2	90° hjørne
	3	trappe
	4	Start/slut trappe

## Side monteret

Rustfri	Ude/Indendørs	
Vare nr.	Nr.	Type
021101	1	For vandret montage
	2	Trappe
	3	Start/slut trappe
	4	Udvendigt 90° hjørne
	5	Indvendigt 90° hjørne

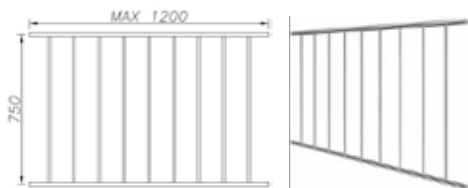

## Gelænder moduler

Rustfri	Ude/Indendørs	
Vare nr.	Type	Max længde
022140	Modul ligeløb	1200 mm.
022114	Modul trappe	1200 mm.

## Rør

Rustfri	Ude/Indendørs	
Vare nr.	Type	Max længde
022135	Rør Ø43 mm.	6000 mm.



## Endeluk

Rustfri	Ude/Indendørs	
Vare nr.	Type	
022136	Rør Ø43 mm.	
022137	Endeluk Ø22 mm.	

# TOP RAILING

## B-Inox serie 200

2



**For projekterende.**  
beskrivelse til udbudsmateriale.

### MAB TOP RAILING B-Inox serie 200

- Top eller Sidemonetert
- Rustfri stål stolper fremstillet i 50x12 mm. stål.
- Højde 1000 eller 1100 mm.
- Børstet eller blank overflade.
- Max afstand mellem septre 1200 mm.
- leveres med 3,4,5 og 6 kugleforbindelser, MAB anbefalder dog ikke under 5.

Kontakt os for DWG tegninger og specifikke tekniske detaljer.



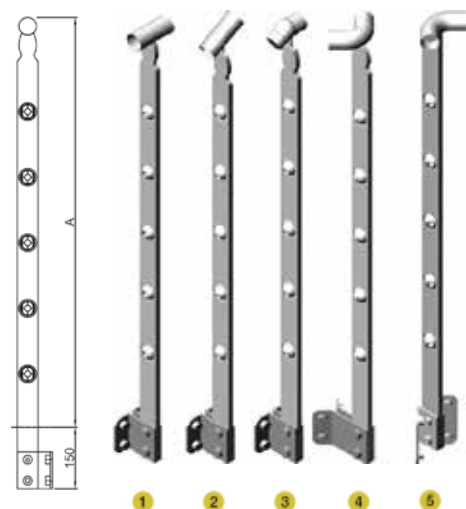
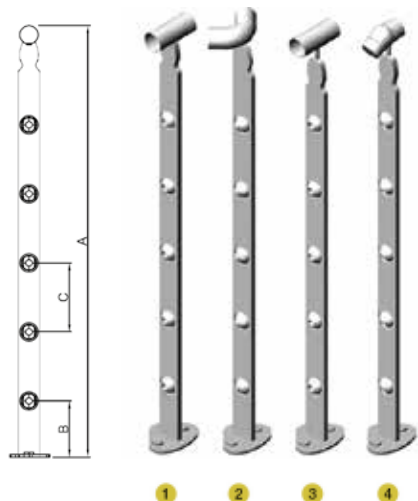

### Top monteret

Rustfri	Ude/Indendørs	
Vare nr. 021110	<b>Nr.</b>	<b>Type</b>
	1	For vandret montage
	2	90° hjørne
	3	trappe
4	Start/slut trappe	

### Side monteret

Rustfri	Ude/Indendørs	
Vare nr. 021111	<b>Nr.</b>	<b>Type</b>
	1	For vandret montage
	2	Trappe
	3	Start/slut trappe
	4	Udvendigt 90° hjørne
5	Indvendigt 90° hjørne	

### INFO

Type	Afstand B	Afstand C
3 kugleforbindelser	150 mm.	300 mm.
4 kugleforbindelser	150 mm.	200 mm.
5 kugleforbindelser	130 mm.	160 mm.
6 kugleforbindelser	130 mm.	115 mm.

### Rør

Rustfri	Ude/Indendørs	
<b>Vare nr.</b>	<b>Type</b>	<b>Max længde</b>
021134	Rør Ø15 mm.	6000 mm.

### Endeluk

Rustfri	Ude/Indendørs	
<b>Vare nr.</b>	<b>Type</b>	
021137	Endeluk for rør Ø15	



# TOP RAILING

## B-Inox serie 300

2



**For projekterende.**  
beskrivelse til udbudsmateriale.

### **MAB TOP RAILING** **B-inox serie 300**

- Top eller Sidemonetert
- Rustfri stål stolper fremstillet i 50x12 mm. stål.
- Højde 1000 eller 1100 mm.
- Børstet eller blank overflade.
- Max afstand mellem septre 1500 mm.

Kontakt os for DWG tegninger  
og specifikke tekniske detaljer.





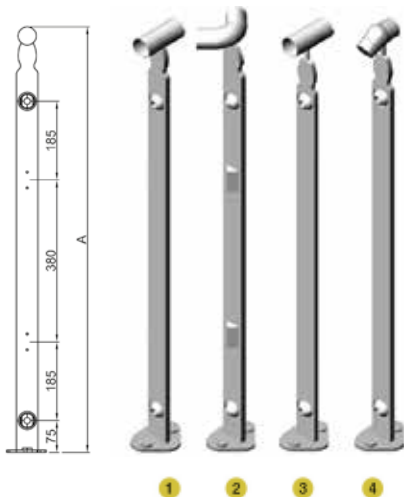

## Top monteret

Rustfri	Ude/Indendørs	
<b>Nr.</b>	<b>Type</b>	
1	For vandret montage	
<b>Vare nr.</b> 021120	2	90° hjørne
	3	trappe
	4	Start/slut trappe

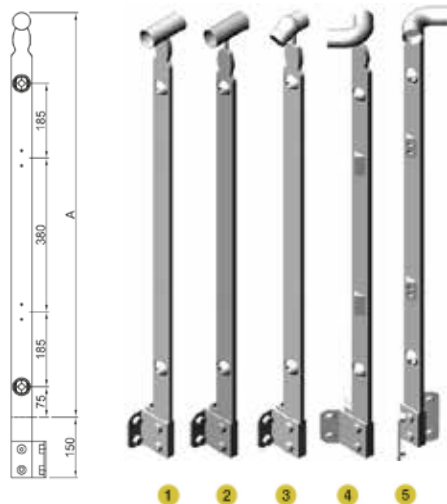

## Side monteret

Rustfri	Ude/Indendørs	
<b>Nr.</b>	<b>Type</b>	
1	For vandret montage	
<b>Vare nr.</b> 021121	2	Trappe
	3	Start/slut trappe
	4	Udvendigt 90° hjørne
	5	Indvendigt 90° hjørne



### INFO

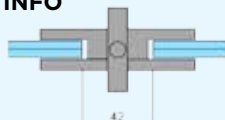

Afstand fra glaskant til glaskant er 42 mm.

## Clamp

AISI 304	Indendørs
<b>Vare nr.</b>	<b>Glas</b>
021220	8-8.76 mm.
021221	10-10.76 mm.
021222	12-12.76 mm.

## Clamp

AISI 316	Indendørs
<b>Vare nr.</b>	<b>Glas</b>
021223	8-8.76 mm.
021224	10-10.76 mm.
021225	12-12.76 mm.



## Rør

Rustfri	Ude/Indendørs	
<b>Vare nr.</b>	<b>Type</b>	<b>Max længde</b>
021134	Rør Ø15 mm.	6000 mm.



## Endeluk

Rustfri	Ude/Indendørs
<b>Vare nr.</b>	<b>Type</b>
021137	Endeluk for rør Ø15

# TOP RAILING

## B-Inox serie 310

2



**For projekterende.**  
beskrivelse til udbudsmateriale.

### **MAB TOP RAILING B-inox serie 310**

- Top eller Sidemonetert
- Rustfri stål stolper fremstillet i 50x12 mm. stål.
- Højde 1000 eller 1100 mm.
- Børstet eller blank overflade.
- Max afstand mellem septre 1500 mm.
- Glas limes i profilerme med klar silikone

Kontakt os for DWG tegninger og specifikke tekniske detaljer.



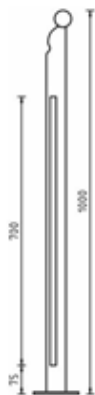

## Top monteret

Rustfri	Ude/Indendørs	
Vare nr. 021125	Nr.	Type
	1	Venstre
	2	Højre
	3	Dobbelt sidet
	4	90° hjørne

Rustfri	Ude/Indendørs	
Vare nr. 021125	Nr.	Type
	5	Hjørne valgfri vinkel
	6	Start/slut trappe
	7	Trappe enkelt venstre
	8	Trappe enkelt højre
	9	Trappe dobbelt



## Side monteret

Rustfri	Ude/Indendørs	
Vare nr. 021123	Nr.	Type
	1	Venstre
	2	Højre
	3	Dobbelt sidet
	4	90° hjørne udvendigt

Rustfri	Ude/Indendørs	
Vare nr. 021123	Nr.	Type
	5	90° hjørne indvendig
	6	Start/slut trappe
	7	Trappe enkelt venstre
	8	Trappe enkelt højre
	9	Trappe dobbelt

### INFO!

Afstand fra glas-kant til glasskant er 25 mm.

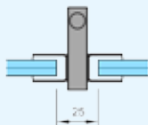

### INFO!

310 postene, fås også som en "light" udgave, hvor postene er fremstillet i 50x8 mm. A 304 stål. i stedet for normalt 50x12 mm. stål. Ved bestilling angives at man ønsker 310 light!

# TOP RAILING

## B-Inox serie 320

2



**For projekterende.**  
beskrivelse til udbudsmateriale.

### **MAB TOP RAILING B-inox serie 320**

- Top eller Sidemonetert
- Rustfri stål stolper fremstillet i 50x12 mm. stål.
- Højde 1000 eller 1100 mm.
- Børstet eller blank overflade.
- Max afstand mellem septre 1000 mm.
- Glas limes i profilerme med klar silikone

Kontakt os for DWG tegninger og specifikke tekniske detaljer.



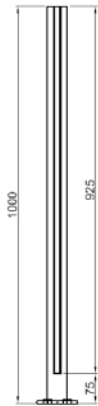

## Top monteret

Rustfri	Ude/Indendørs	
Nr.	Type	
Vare nr. 021126	1	Venstre / Højre
	2	Dobbelt sidet
	3	90° hjørne

## Top monteret

Rustfri	Ude/Indendørs	
Nr.	Type	
Vare nr. 021126	4	Start/slut trappe
	5	Trappe enkelt venstre
	6	Trappe enkelt højre
	7	Trappe dobbelt

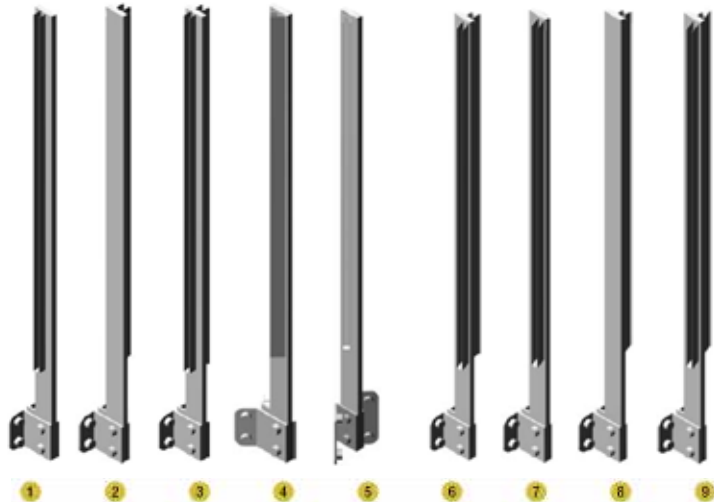
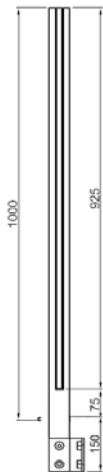

## Side

Rustfri	Ude/Indendørs	
Nr.	Type	
Vare nr. 021124	1	Venstre
	2	Højre
	3	Dobbelt sidet
	4	90° hjørne

## Side monteret

Rustfri	Ude/Indendørs	
Nr.	Type	
Vare nr. 021124	5	90° hjørne invendig
	6	Start/slut trappe
	7	Trappe enkelt venstre
	8	Trappe enkelt højre
	9	Trappe dobbelt



# TOP RAILING

## B-Inox serie 400

2



**For projekterende.**  
beskrivelse til udbudsmateriale.

### **MAB TOP RAILING** **B-inox serie 320**

- Top eller Sidemonetert
- Rustfri stål stolper fremstillet i 50x12 mm. stål.
- Højde 1000 eller 1100 mm.
- Børstet eller blank overflade.
- Max afstand mellem septrer 1500 mm.

Kontakt os for DWG tegninger og specifikke tekniske detaljer.



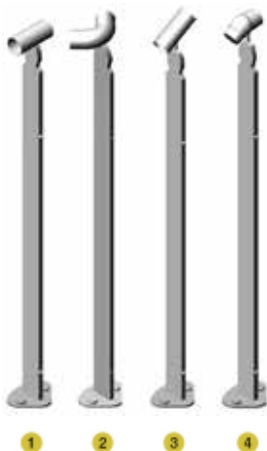

2

## Top monteret

Rustfri	Ude/Indendørs	
Nr.	Type	
1	For vandret montage	
<b>Vare nr.</b> 021127	2	90° hjørne
	3	Trappe
	4	Start/slut trappe

## Side monteret

Rustfri	Ude/Indendørs	
Nr.	Type	
1	For vandret montage	
<b>Vare nr.</b> 021122	2	Trappe
	3	Start/slut trappe
	4	Udvendigt 90° hjørne
	5	Indvendigt 90° hjørne



## Enkelt klemleslag

Rustfri	Ude/Indendørs	
Vare nr.		
021128		

## Dobbelt klemleslag

Rustfri	Ude/Indendørs	
Vare nr.		
021129	Uden stop	
021131	m/stop	



## Hjørne klemleslag

Rustfri	Ude/Indendørs	
Vare nr.	Type	
021130	Udvendig hjørne	
021132	Invendig hjørne	

# TOP RAILING

## B-Inox kubic serie 40.300

2



**For projekterende.**  
beskrivelse til udbudsmateriale.

### **MAB TOP RAILING** **B-inox serie 40.300**

- Top eller Sidemonetert
- Rustfri stål stolper fremstillet i 40x40x2 mm. stål.
- Højde 1000 eller 1150 mm.
- Børstet eller blank overflade.

Kontakt os for DWG tegninger  
og specifikke tekniske detaljer.





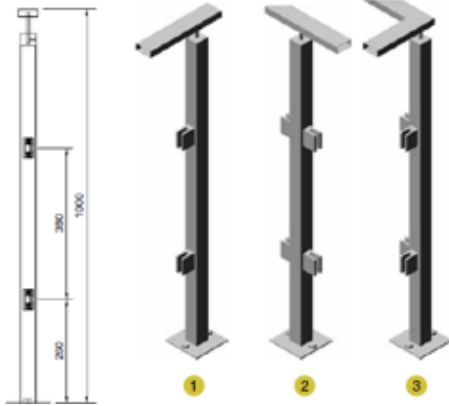

**Top monteret 40.301**

Rustfri			Ude/Indendørs
Vare nr. 021312	Nr.	Type	
	1	Enkelt	
	2	Dobbelt	
	3	90° hjørne	



**Side monteret 40.301**

Rustfri			Ude/Indendørs
Vare nr. 021313	Nr.	Type	
	1	Enkelt	
	2	Dobbelt	
	3	90° hjørne	

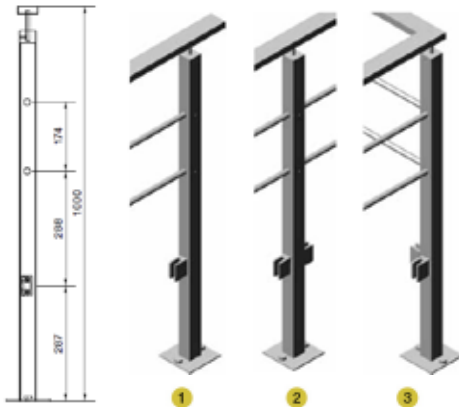

**Top monteret 40.302**

Rustfri			Ude/Indendørs
Vare nr. 021314	Nr.	Type	
	1	Enkelt	
	2	Dobbelt	
	3	90° hjørne	

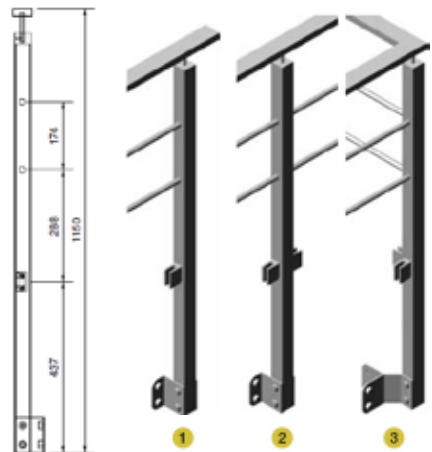

**Side monteret 40.302**

Rustfri			Ude/Indendørs
Vare nr. 021315	Nr.	Type	
	1	Enkelt	
	2	Dobbelt	
	3	90° hjørne	

# TOP RAILING

## B-Inox kubic serie 40.310

2



**For projekterende.**  
beskrivelse til udbudsmateriale.

### **MAB TOP RAILING B-inox serie 40.310**

- Top eller Sidemonetert
- Rustfri stål stolper fremstillet i 40x40x2 mm. stål.
- Højde 1000 eller 1150 mm.
- Børstet eller blank overflade.
- Glas limes i profilerne med klar silikone

Kontakt os for DWG tegninger  
og specifikke tekniske detaljer.



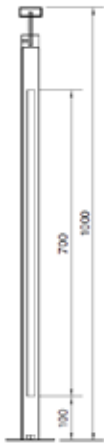

## Top monteret

Rustfri	Ude/Indendørs	
Vare nr.	Nr.	Type
021316	1	Venstre/Højre
	2	Dobbelt sidet
	3	90° hjørne

Rustfri	Ude/Indendørs	
Vare nr.	Nr.	Type
021316	4	Trappe start
	5	Trappe enkelt
	6	Trappe dobbelt



## Side monteret

Rustfri	Ude/Indendørs	
Vare nr.	Nr.	Type
021317	1	Venstre/Højre
	2	Dobbelt sidet
	3	90° hjørne

Rustfri	Ude/Indendørs	
Vare nr.	Nr.	Type
021317	4	Trappe enkelt
	5	Trappe dobbelt

# TOP RAILING

## B-Inox kubic serie 40.320

2



**For projekterende.**  
beskrivelse til udbudsmateriale.

### **MAB TOP RAILING** **B-inox serie 40.320**

- Top eller Sidemonetert
- Rustfri stål stolper fremstillet i 40x40x2 mm. stål.
- Højde 1000 eller 1150 mm.
- Børstet eller blank overflade.
- Glas limes i profilerne med klar silikone

Kontakt os for DWG tegninger  
og specifikke tekniske detaljer.





## Top monteret

Rustfri	Ude/Indendørs	
Vare nr.	Nr.	Type
021318	1	Venstre/Højre
	2	Dobbelt sidet
	3	90° hjørne

Rustfri	Ude/Indendørs	
Vare nr.	Nr.	Type
021318	4	Trappe start
	5	Trappe enkelt
	6	Trappe dobbelt



## Side monteret

Rustfri	Ude/Indendørs	
Vare nr.	Nr.	Type
021319	1	Venstre/Højre
	2	Dobbelt sidet
	3	90° hjørne

Rustfri	Ude/Indendørs	
Vare nr.	Nr.	Type
021319	4	Trappe enkelt
	5	Trappe dobbelt

# Top Railing B-Inox låger

2



MAB Låger er fremstillet i rustfrit stål 316L samt 316 og 304.

fremstillet af 25 mm. og 15 mm. rør. option med glas i stedet for 15 mm. rør.

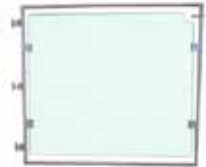

## MAB låger

Rustfri	Ude/Indendørs	
Vare nr.	Type	Dimensioner
021195	Låge m/stænger	Valgfri
	Låge m/glas	Valgfri

Leveres med 2 eller 3 vægbeslag som kan justeres i afstanden mellem væg og låge. og standard med skyde rigle, alternativt kan der monteres låsekasse.

MAB Låger special fremstilles på ønskede mål og udseende. Ved bestilling oplyses de ønskede mål på lågen!



Ønskes en glas låge, uden rustfri ramme, fåes der også hængsler og lås til dette.

Lås leveres med anslag til poste eller vægmontage.

## Glas hængsler

Rustfri	Ude/Indendørs	
Vare nr.	Type	Glas
021112	Låsekasse og 2 hængsler	6-8-10 mm.



TOP RAILING B-inox SM er den ideelle løsning til balkoner eller andre konstruktioner, hvor et topgelænder er nødvendigt.

Højden på poste angives ved bestilling.

## Topgelænder SM

Rustfri		Ude/Indendørs
Vare nr.	Type	Dimensioner
021118	Lige septer	Efter mål
021119	90° hjørne	Efter mål

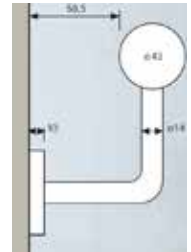

TOP RAILING B-inox PS og PS-V er den perfekte løsning eller som supplement til andre B-inox løsninger.

Både til montering på væg og glas. Ved brug af de forskellige samle stykker, som findes under tilbehør, kan man sammen sætte håndlisten helt som man ønsker det.

Ved bestilling oplyses de ønskede mål, samt hvilket tilbehør der ønskes.

## Håndliste

Rustfri		Ude/Indendørs
Vare nr.	Type	Dimensioner
021240	PS Væg montage	Efter mål
021239	PS-V Glas montage	Efter mål

# Top Railing B-Inox tilbehør

2



90° hjørne

Rustfri		Ude/Indendørs
Vare nr.	Type	
021141	90° hjørne	



Regulerbart kugleled

Rustfri		Ude/Indendørs
Vare nr.	Type	
021139	Regulerbart kugleled	

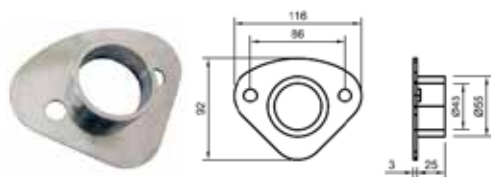

Vægplade til håndliste lige

Rustfri		Ude/Indendørs
Vare nr.	Type	
021138	Vægplade til håndliste lige	

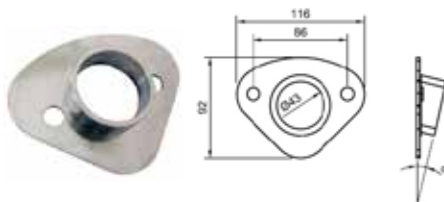

Vægplade til håndliste vinkel

Rustfri		Ude/Indendørs
Vare nr.	Type	
021113	Vægplade til håndliste vinkel	



Forankringsbase

Rustfri		Ude/Indendørs
Vare nr.	Type	
021114	Forankringsbase std. top montage	
021115	Forankringsbase std. side montage	

MAB Glas anbefaler brugen af forankringsbase, da den forstærker fæstningen af gelænderet.

Kontakt MAB glas for andre typer af forankringsbaser.



Montage skruer

Rustfri		Ude/Indendørs
Vare nr.	Type	
021230	Skruer Kit, beton montage, 2 stk.	
021231	Skruer Kit, beton montage, 4 stk.	
021232	Skruer Kit, metal montage, 2 stk.	

Sættene leveres med rustfri stål hætte, skive med gevind, for på skrue.

Dette sikre et super udseende på gelænderet!



# Top Railing B-Inox tilbehør

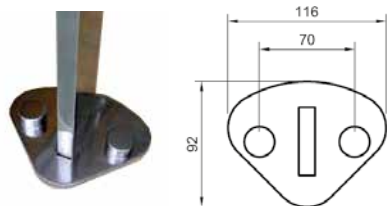

Standart fod

Rustfri		Ude/Indendørs
Ref. nr.	Type	
TF01	Standart fod (dog ikke B-inox 320)	

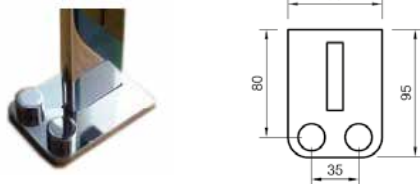

Asymetrisk fod

Rustfri		Ude/Indendørs
Ref. nr.	Type	
TF05	Asymetrisk fod	

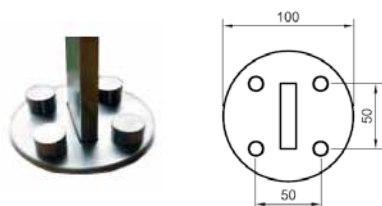

Standart fod for B-inox 320

Rustfri		Ude/Indendørs
Ref. nr.	Type	
TF02	Standart fod for B-inox 320	

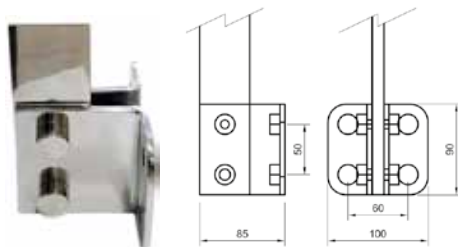

Standart sidemonteret fod

Rustfri		Ude/Indendørs
Ref. nr.	Type	
SF06	35 mm offset	

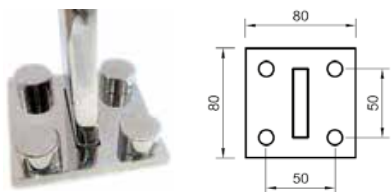

Firkantet fod

Rustfri		Ude/Indendørs
Ref. nr.	Type	
TF03	Firkantet fod	

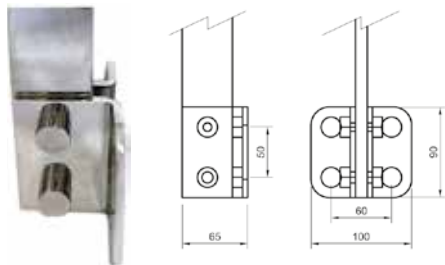

Sidemonteret fod

Rustfri		Ude/Indendørs
Ref. nr.	Type	
SF07	15 mm offset	

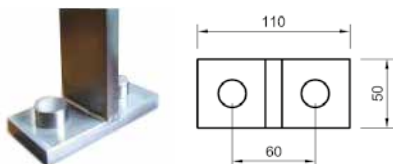

Rektangulær fod

Rustfri		Ude/Indendørs
Ref. nr.	Type	
TF04	Rektangulær fod	

## INFO

Ved bestilling angives at man ønsker anden fod på septrene, og hvilket Ref nummer man ønsker!

# Top Railing befæstigelse

2

## Umbraco skrue

AISI 304		Indendørs / Indoor
Vare nr.	Type	
033454	M6 x 16 mm.	
033473	M8 x 20 mm.	

## Umbraco skrue

AISI 316		Udendørs / Outdoor
Vare nr.	Type	
033455	M6 x 16 mm.	
033474	M8 x 20 mm.	



\*OBS! gevindbøsningerne kræver special værktøj!

## Gevind bøsning\*

AISI 316		Udendørs / Outdoor
Vare nr.	Gevind	
033467	M6	
033475	M8	



\*OBS! gevindbøsningerne kræver special værktøj!

## Undersænket gevind bøsning\*

AISI 316		Udendørs / Outdoor
Vare nr.	Gevind	
033477	M8	



## Umbraco "buttonhead" for railing håndliste

AISI 316		Udendørs / Outdoor
Vare nr.	Type	
033493	M5 x 10 mm. "buttonhead"	



## Bor HHS 4.1 mm

AISI 316		
Vare nr.	Type	
033489	HHS 4.1 mm.	



## Snittap M5

AISI 316		
Vare nr.	Type	
033485	Snittap M5	



## Popnitter

Alu		Udendørs / Outdoor
Vare nr.	Type	
034315	3.2x10 mm.	

## Popnitter

AISI 316		Udendørs / Outdoor	
Vare nr.	Type	Pakning	
033479	Popnitter 4.8 x 12.0 mm.	10 stk.	



## Fransk skrue

AISI 316		Udendørs / Outdoor
Vare nr.	Type	
033469	8 x 60 mm.	

## Træ skrue

AISI 304		Indendørs / Indoor
Vare nr.	Type	
033464	6 x 60 mm	

2

## Træ skrue

AISI 316		Udendørs / Outdoor
Vare nr.	Type	
033465	6 x 60 mm	



## Betonanker

AISI 316		
Vare nr.	Type	
033445	8 x 116 mm.	



## Undersænket umbraco skrue

AISI 304		Indendørs / Indoor
Vare nr.	Type	
034208	M5 x 10 mm.	
033450	M6 x 10 mm.	
033452	M6 x 25 mm.	
033446	M8 x 25 mm.	
033448	M8 x 50 mm.	
033486	M10 x 40 mm	

## Montage skruer undersænket

AISI 304		Indendørs / Indoor
Vare nr.	Type	Pakning
022521	7,5x52 mm.	10 stk.
022522	7,5x72 mm.	10 stk.
022523	7,5x92 mm.	10 stk.
022524	7,5x112 mm.	10 stk.

## Undersænket umbraco skrue

AISI 316		Udendørs / Outdoor
Vare nr.	Type	
034207	M5 x 10 mm.	
033451	M6 x 10 mm.	
033453	M6 x 25 mm.	
033447	M8 x 25 mm.	
033449	M8 x 50 mm.	
033487	M10 x 40 mm.	



## Skrue

AISI 316		Udendørs / Outdoor
Vare nr.	Type	
034314	4.8x13 mm.	

2



## LED For Ø 42.4 Rør

Belysning			Udendørs / Outdoor
Vare nr.	Forbrug	Spænding	
033720	2 W	24 V	



.....Let there be light!



## Transformer

Belysning			Udendørs / Outdoor
Vare nr.	Max forbrug	Spænding	
033721	70 W	24 V	
033722	130 W	24 V	

## Softstarter

Belysning		Udendørs / Outdoor
Vare nr.	Spænding	
033723	24 V	



## Ledning

Belysning		Udendørs / Outdoor
Vare nr.	Type	Længde
033724	Rød 1 mm <sup>2</sup>	100 m.
033725	Sort 1 mm <sup>2</sup>	100 m.

## Gummi gennemføring

Belysning		Udendørs / Outdoor
Vare nr.	Type	Hul i rør
033726	Beskyttelse af kabel	Ø 9 mm.





## Låsevæske

Tilbehør	Inde og udendørs
Vare nr.	Anvendelse
033330	Sikring af skruer og bolte



## Affedtnings spray

Tilbehør	Inde og udendørs
Vare nr.	Anvendelse
033332	Rengøring af alle overflader for fedtstof



## Rengøring og beskyttelses spray

Tilbehør	Inde og udendørs
Vare nr.	Anvendelse
033333	Rengør og polering af rustfrie ståloverflader



## Afrensers

Tilbehør	Inde og udendørs
Vare nr.	Anvendelse
033334	Fjerner fedt aflejringer og rustpletter



## Beskyttelsepasta

Tilbehør	Inde og udendørs
Vare nr.	Anvendelse
033335	Beskytter metal overflader



## M3 scotch brite klude

Tilbehør	Inde og udendørs
Vare nr.	Anvendelse
033336	Polere af børstede rustfrie overflader



## Lim

Tilbehør	Inde og udendørs
Vare nr.	Anvendelse
033331	Limning endekapper osv.

## Sådan rengøre og vedligeholder du rustfrit stål

På byggerier skyller regnen ofte overfladerne rene. Det kan dog være nødvendigt med skylning og afvaskning med vand eller sæbevand, hvis den naturlige skylning ikke er tilstrækkelig. I bymiljø kan en afvaskning være nødvendig 1 til 2 gange årligt, hvor det i kystmiljøer er nødvendigt 2 til 4 gange årligt.

Hvis der på overfladerne er opstået pletter eller misfarvninger af mere alvorlig karakter, kan du rengøre stålet på denne måde:

### Fingeraftryk

Sprit, acetone eller fortynder, afvask med rent vand. (*Affedtnings spray 033332*)

### Olie og fedt

Sprit, acetone eller fortynder, vask med sæbevand, skyl med rent vand. (*Affedtnings spray 033332*)

### Pletter og misfarvninger

Rens med slibende rengøringsmiddel i strukturretningen, skyl med rent vand, alternativt vask med en 10 % fosforsyreopløsning, skyl med ammoniumopløsning og rent vand. (*afrensers 033334 - M3 scotch 033336 - Rengøring 033333*)

### Misfarvning efter rust

Påfør oxalsyreopløsning og skyl med rent vand efter 15 - 20 min. Om nødvendigt rens med slibende rengøringsmiddel og skyl. (*afrensers 033334 M3 scotch 033336*)

Rengøring af rustfrit stål er således baseret på erfaring, og der kan derfor ikke gives garanti for virkningen. I tvivlstilfælde bør du indhente specialisten.



## Rengørings kit

Tilbehør	Inde og udendørs
Vare nr.	Anvendelse
033337	Anvendes hovedsagelig til svejsninger





# MAB GLAS SKANDINAVIEN

*dit sikre valg!*

MAB GLAS SKANDINAVIEN  
Ulvevej 13  
DK-7800 Skive  
Danmark

Tlf.: +45 9752 6533  
Fax: +45 9752 1622  
info@mabglas.dk  
www.mabglas.dk







## ALU RAILING

Glasværn

Gelændersystemer



# ALU RAILING

## Profil system

2



### For projekterende.

beskrivelse til udbudsmateriale.

#### MAB ALU RAILING profil system.

Top eller Sidemoneteret  
Alu profiler 70x30 mm.

#### Secur sikkerhedsglas

MAB secur hærdet lamineret  
glas 44.2 (8.76 mm.) eller  
55.2 (10.76 mm.)

#### Overflade

Anodiseret aluminium, efter  
ønske kan vi levere lakeret i RAL  
farver.

Kontakt os for DWG tegninger  
og specifikke tekniske detaljer.

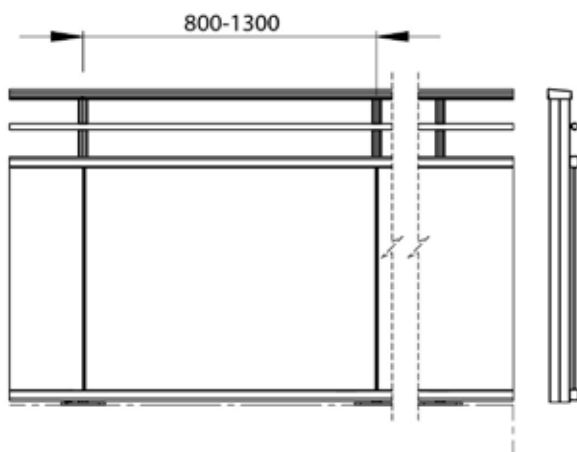

## Montage princip for aluminium profil system

Detalje A

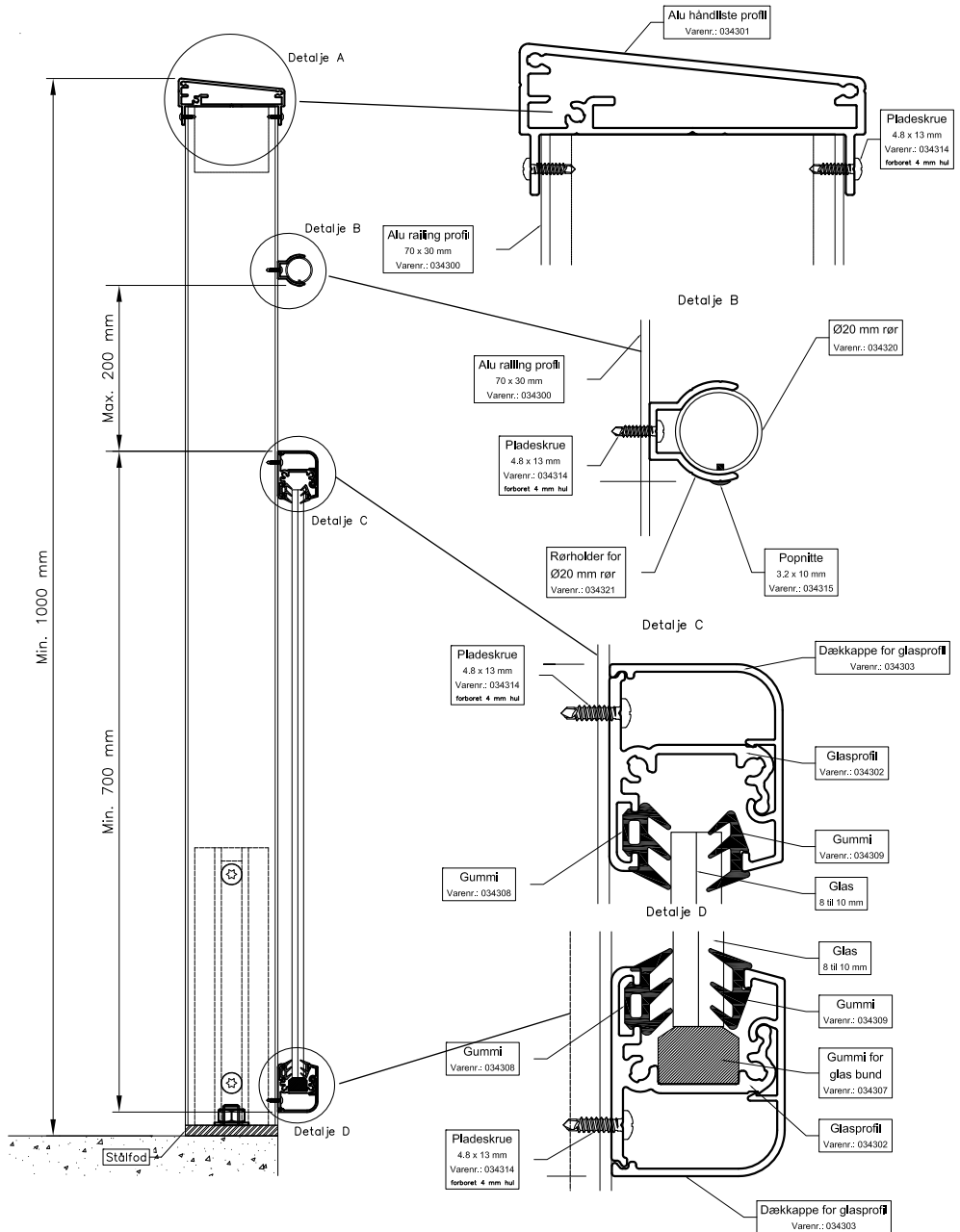

# Alu Railing profil system



## Alu railing profil

Alu	Udendørs / Outdoor	
Vare nr.	Type	længde
034300	Profil til septré	6000 mm.

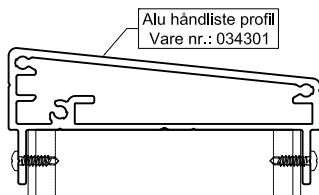

## Alu håndliste profil

Alu	Udendørs / Outdoor	
Vare nr.	Type	længde
034301	Profil til håndliste	6000 mm.

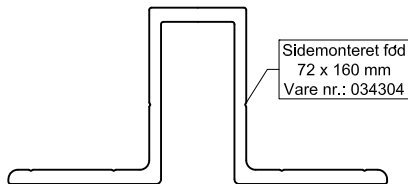

## Fod for sidemonteret stolpe.

Alu	Udendørs / Outdoor	
Vare nr.	Type	
034304	Montage af stolper på forkant.	

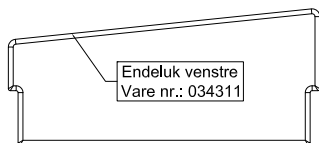

## Endeluk håndliste

Plast	Udendørs / Outdoor	
Vare nr.	Type	
034311	Venstre	
034312	Højre	

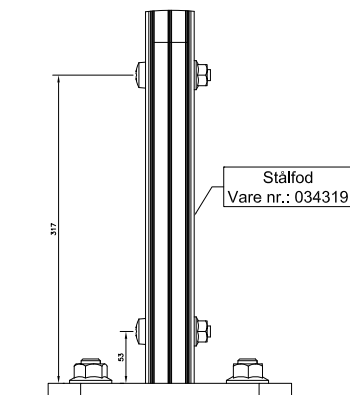

## Fod for topmonteret stolpe

Alu	Udendørs / Outdoor	
Vare nr.	Type	
034319	Top montage af stolper.	

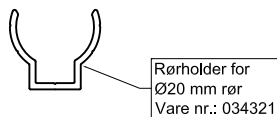

## Rørholder for Ø20 mm. rør

Alu	Udendørs / Outdoor	
Vare nr.	Type	
034321	Holder for rør Ø20 mm.	



## Ø20 mm. rør

Alu	Udendørs / Outdoor	
Vare nr.	Type	
034320	Rør Ø20 mm.	

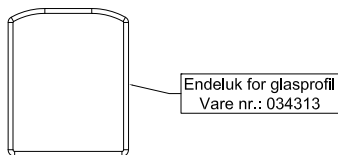
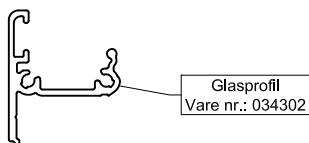

## Glasprofil

Alu	Udendørs / Outdoor
<b>Vare nr.</b>	<b>Type</b>
034302	Basisprofil glasmontage

## Endeluk for glasprofil.

Plast	Udendørs / Outdoor
<b>Vare nr.</b>	<b>Type</b>
034313	Endeluk for glasliste natur elokseret

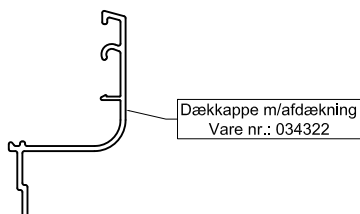
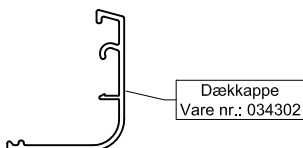

## Dækkappe glasliste

Alu	Udendørs / Outdoor
<b>Vare nr.</b>	<b>Type</b>
034303	Dækkappe til basisprofil

## Dækkappe m/afdækning

Alu	Udendørs / Outdoor
<b>Vare nr.</b>	<b>Type</b>
034322	Dækkappe til basisprofil m/afdækning

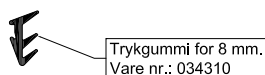
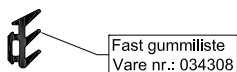

## Gummi for basis glasprofil

Gummi	Udendørs / Outdoor
<b>Vare nr.</b>	<b>Type</b>
034308	Fast gummi liste

## Tryk gummi for 8 mm. glas

Gummi	Udendørs / Outdoor
<b>Vare nr.</b>	<b>Type</b>
034310	For 8 mm. glas

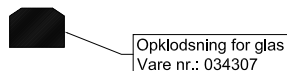
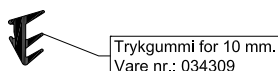

## Tryk gummi for 10 mm. glas

Gummi	Udendørs / Outdoor
<b>Vare nr.</b>	<b>Type</b>
034309	For 10 mm. glas

## Opklodsning for glas bund.

Gummi	Udendørs / Outdoor
<b>Vare nr.</b>	<b>Type</b>
034307	Opklodsning af glas i bund skinnen

2



## Skrue for alu-railing

AISI 316		Udendørs / Outdoor
Vare nr.	Type	
034314	4.8x13 mm.	



## Popnitter for alu-railing

Alu		Udendørs / Outdoor
Vare nr.	Type	
034315	3.2x10 mm.	



## Bolt for alu-railing

AISI 316		Udendørs / Outdoor
Vare nr.	Type	
034316	M8x50 bolt	



## Selv l sende m trik for alu-railing

AISI 316		Udendørs / Outdoor
Vare nr.	Type	
034318	M8	



## Skive for alurailing M8

AISI 316		Udendørs / Outdoor
Vare nr.	Type	
034317	Skive M8	

MAB  
GLASS





# ALU RAILING

Top eller sidemonteret

2



## For projekterende.

beskrivelse til udbudsmateriale.

### MAB ALU RAILING

Top eller Sidemonteret  
Rør Ø42,4/Ø50 mm.

### Secur sikkerhedsglas

MAB secur hærdet lamineret  
glas 44.2 (8.76 mm.) eller  
55.2 (10.76 mm.)

### Finish

Anodiseret, Rustfri look eller  
lakeret i RAL farve efter ønske.

Kontakt os for DWG tegninger  
og specifikke tekniske detaljer.



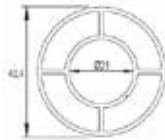

## Rør Ø42.4 mm. For stolper

Alu		Udendørs / Outdoor
Vare nr.	Type	Ø
034350	Stolpe profil rør	42.4 mm.

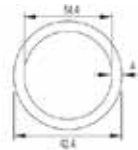

## Rør Ø42.4 mm.

Alu		Udendørs / Outdoor
Vare nr.	Type	Ø
034351	Rør	42.4 mm.

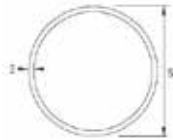

## Rør for håndliste

Alu		Udendørs / Outdoor
Vare nr.	Type	Ø
034352	Håndliste	50 mm.

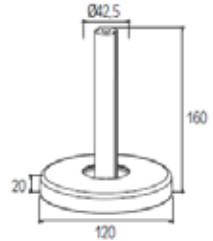

## Fod

Alu		Udendørs / Outdoor
Vare nr.	Type	
034355	Fod	

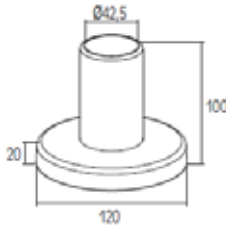

## Fod

Alu		Udendørs / Outdoor
Vare nr.	Type	
034356	Fod	

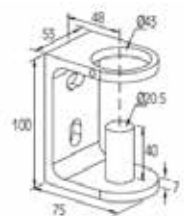

## Sidemonteret fod

Alu		Udendørs / Outdoor
Vare nr.	Type	
034357	Fod	

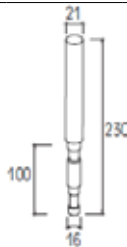

## Fod for nedstøbning

Alu		Udendørs / Outdoor
Vare nr.	Type	
034358	Fod	

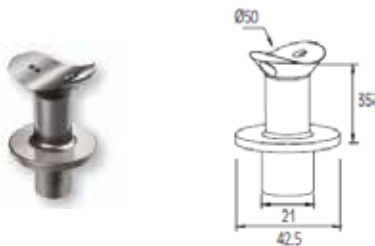

## Håndliste holder lige

Alu	Udendørs / Outdoor	
Vare nr.	Type	Ø
034360	For håndliste Ø50 mm.	42.4

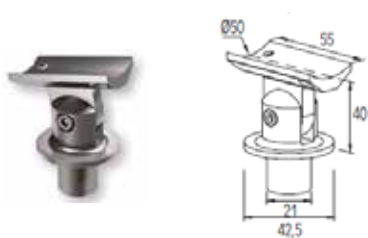

## Håndliste holder justerbar

Alu	Udendørs / Outdoor	
Vare nr.	Type	Ø
034361	For håndliste Ø50 mm.	42.4

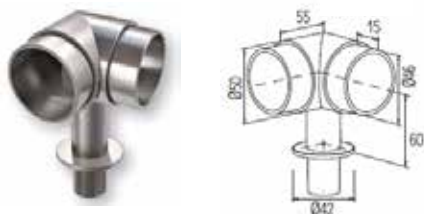

## Håndliste holder lige

Alu	Udendørs / Outdoor	
Vare nr.	Type	Ø
034365	For håndliste Ø50 mm.	42.4

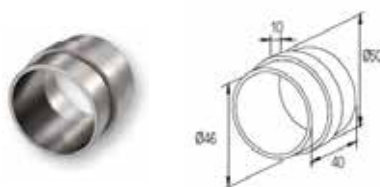

## Samle stykke

Alu	Udendørs / Outdoor	
Vare nr.	Type	Ø
034366	For håndliste Ø50 mm.	50



## 90° Hjørne vinkel

Alu	Udendørs / Outdoor	
Vare nr.	Type	Ø
34367	For håndliste Ø50 mm.	50



## Justerbart led (eks. til trappe)

Alu	Udendørs / Outdoor	
Vare nr.	Type	Ø
034368	For håndliste Ø50 mm.	50

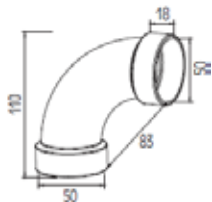

## 90° Hjørne

Alu	Udendørs / Outdoor	
Vare nr.	Type	Ø
034369	For håndliste Ø50 mm.	50

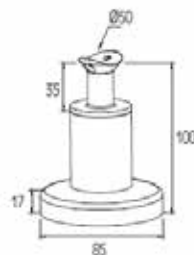

## Støtte til topmonteret håndliste

Alu	Udendørs / Outdoor	
Vare nr.	Type	Ø
034370	For håndliste Ø50 mm.	50

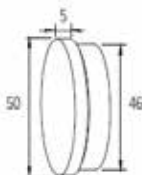

## Endeluk flad

Alu	Udendørs / Outdoor	
Vare nr.	Type	Ø
034375	For håndliste Ø50 mm.	50

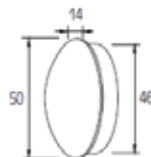

## Endeluk afrundet

Alu	Udendørs / Outdoor	
Vare nr.	Type	Ø
034376	For håndliste Ø50 mm.	50

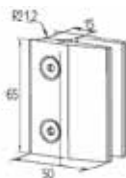

## Klemeslag firkantet

Alu	Udendørs / Outdoor	
Vare nr.	Type	Glas
034380	For rør Ø42.4 mm.	8-10

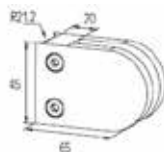

## Klemeslag rund

Alu	Udendørs / Outdoor	
Vare nr.	Type	Glas
034381	For rør Ø42.4 mm.	8-10

# MAB GLAS SKANDINAVIEN

*dit sikre valg!*

MAB GLAS SKANDINAVIEN  
Ulvevej 13  
DK-7800 Skive  
Danmark

Tlf.: +45 9752 6533  
Fax: +45 9752 1622  
info@mabglas.dk  
www.mabglas.dk

